

Balboa's BP Troubleshooting & Service Manual

THIS MANUAL COVERS THE FOLLOWING:

SPA CONTROL SYSTEMS

BP500
BP2000G1

PANELS

TP900, TP800,
TP600, TP400

60 Hz



BALBOA
water group

Introduction

Intellectual Property Advisement

All Intellectual property, as defined below, owned by or which is otherwise the property of Balboa Water Group or its respective suppliers relating to the Balboa Water Group BP500 Spa Control, including but not limited to, accessories, parts, or software relating there to (the "System"), is proprietary to Balboa Water Group and protected under federal laws, state laws, and international treaty provisions. Intellectual Property includes, but is not limited to, inventions (patentable or unpatentable), patents, trade secrets, copyrights, software, computer programs, and related documentation, and other works of authorship. You may not infringe or otherwise violate the rights secured by the Intellectual Property. Moreover, you agree that you will not (and will not attempt to) modify, prepare derivative works of, reverse engineer, decompile, disassemble, or otherwise attempt to create source code from the software. No title to or ownership in the Intellectual Property is transferred to you. All applicable rights of the Intellectual Property shall remain with Balboa Water Group and its suppliers.

End User Warning

This Installation Manual is provided solely to aid qualified spa service technicians in installing spas with control systems manufactured by Balboa Water Group. Balboa controls have absolutely no end user serviceable parts. Balboa Water Group does not authorize attempts by the spa owner/user to repair or service any Balboa products. Non-qualified users should never open or remove covers, as this will expose dangerous voltage points and other dangerous risks. Please contact your dealer or authorized repair center for service.

GFCI

It is required by code to install a Ground Fault Circuit Interrupter (GFCI) in the supply power for a spa. This device will trip the breaker if there is an unsafe electrical condition caused by a malfunctioning component or even the slightest short to ground.

Note: Connect the control system only to a circuit protected by a Class A GFCI mounted at least 5' (1.52M) from the inside walls of the spa/hot tub and in line of sight from the equipment compartment.

Refer to *NEC (National Electrical Code), 2005 Edition, Article 680* for more information.

Warnings: Danger! Risk of Electric Shock!

- All electrical work must be performed by a qualified electrician and must conform to all national, state, and local codes.
- Before making any electrical connections, make certain that the Main Power breaker from the house breaker box has been turned off.
- Do not attempt service of this control system. Contact your dealer or service organization for assistance.
- Do not permit any electric appliance, such as a light, telephone, radio, or television within 5' (1.5m) of a pool or spa.
- Follow all owner's manual power connection instructions.
- Installation must be performed by a licensed electrician and all grounding connections must be properly installed.
- No user serviceable parts.
- Water temperature in excess of 38°C may be injurious to your health.
- Disconnect the electrical power before servicing.
- Keep access door closed.

CAUTION

- Test the ground fault circuit interrupter before each use of the spa.
- Read the instruction manual.
- Adequate drainage must be provided if the equipment is to be installed in a pit.
- To ensure continued protection against shock hazard, use only identical replacement parts when servicing.
- Install a VG Compliant suction guard that is suitably rated to match the maximum flow rate marked.

WARNING:

- Water temperature in excess of 38°C may be injurious to your health.
- Disconnect the electrical power before servicing.
- Keep access door closed.

Codes and Compliance

All of the electrical wiring methods and materials used to complete the electrical installation of the BP control systems must be in accordance with the National Electrical Code or the Canadian Electric Code, as well as any local electrical codes in effect at the time of installation.

The selection of electrical materials required to accomplish this installation and the installation of the control system must be made by, or be under the direct supervision of, a qualified electrician.

The systems herein are classified as a “continuous duty appliance” and is intended primarily for installation at a single family dwelling. The installation recommendations and instructions contained in this manual are directed solely toward these issues.

WARNING!

If there is any doubt whether the system that you are repairing does not have these features, contact a licensed, qualified electrician. **Do not attempt to modify the wiring yourself.**

Warning! Qualified Technician Required for Service and Installation

Basic Installation and Configuration Guidelines

Use minimum 6AWG copper conductors only.

Torque field connections between 21 and 23 in lbs.

Readily accessible disconnecting means to be provided at time of installation.

Permanently connected.

Connect only to a circuit protected by a Class A Ground Fault Circuit Interrupter (GFCI) or Residual Current Device (RCD) mounted at least 5' (1.52M) from the inside walls of the spa/hot tub and in line of sight from the equipment compartment.

CSA enclosure: Type 2

Refer to Wiring Diagram inside the cover of the control enclosure.

Refer to Installation and Safety Instructions provided by the spa manufacturer.

Warning: People with infectious diseases should not use a spa or hot tub.

Warning: To avoid injury, exercise care when entering or exiting the spa or hot tub.

Warning: Do not use a spa or hot tub immediately following strenuous exercise

Warning: Prolonged immersion in a spa or hot tub may be injurious to your health

Warning: Maintain water chemistry in accordance with the Manufacturers instructions.

Warning: The equipment and controls shall be located not less than 1.5 meters horizontally from the spa or hot tub.

Warning! GFCI or RCD Protection.

The Owner should test and reset the GFCI or RCD on a regular basis to verify its function.

Warning! Shock Hazard! No User Serviceable Parts.

Do not attempt service of this control system. Contact your dealer or service organization for assistance. Follow all owner's manual power connection instructions. Installation must be performed by a licensed electrician and all grounding connections must be properly installed.

CSA Compliance/Conformité

Caution:

- Test the ground fault circuit interrupter or residual current device before each use of the spa.
- Read the instruction manual.
- Adequate drainage must be provided if the equipment is to be installed in a pit.
- For use only within an enclosure rated CSA Enclosure 3.
- Connect only to a circuit protected by a Class A ground fault circuit interrupter or residual current device.
- To ensure continued protection against shock hazard, use only identical replacement parts when servicing.
- Install a suitably rated suction guard to match the maximum flow rate marked.

Warning:

- Water temperature in excess of 38°C may be injurious to your health.
- Disconnect the electrical power before servicing.

Attention:

- Toujours vérifier l'efficacité du disjoncteur différentiel avant d'utiliser différentiel avant d'utiliser le bain.
- Lire la notice technique.
- Lorsque l'appareillage est installé dans une fosse, on doit assurer un drainage adéquat.
- Employer uniquement à l'intérieur d'une clôture CSA Enclosure 3.
- Connecter uniquement à un circuit protégé par un disjoncteur différentiel de Class A.
- Afin d'assurer une protection permanente contre le danger de shock électrique, lors de l'entretien employer seulement des pièces de rechange identiques.
- Les prises d'aspiration doivent être équipées de grilles convenant au débit maximal indiqué.

Avertissement:

- Des températures de l'eau supérieures à 38°C peuvent présenter un danger pour la santé.
- Déconnecter du circuit d'alimentation électrique avant l'entretien.

Warning/Advertissement:

- Disconnect the electric power before servicing. Keep access door closed.
- Déconnecter du circuit d'alimentation électrique avant l'entretien. Garder la porte fermée.

Table of Contents

Introduction	2
Intellectual Property Advisement	2
End User Warning	2
GFCI	2
Warnings: Danger! Risk of Electric Shock!	2
Codes and Compliance	3
Service Tools and Parts Checklist	7
TP Panel Overview and User Guides	8
Product Identification	9
General Troubleshooting & Servicing of Spa's Electrical Equipment	10
G.F.C.I. Troubleshooting	11
120 Volt Residential Wiring Schematic with G.F.C.I.	12
240 Volt Residential Wiring Schematic with G.F.C.I.	14
Voltage Checks: Breaker Box, G.F.C.I. & System Box	16
Wiring Checks	17
Testing a System with Power	18
Troubleshooting Pumps, Problem & Cause	22
Acceptable Ranges for Testing Equipment	23
Fuses: Devices, Locations, and Values	24
BP 60Hz Spa Control System Wiring Diagrams	25
Wiring Diagram - BP500, Part Number 56278, Setup No. 1 (as manufactured)	25
Wiring Diagram - BP2000G1, Part Number 56377	26
Wiring Diagram - BP2000G1, Part Number 56377-01	28
Wiring Diagram - BP20MSSH, Part Number: 56373 (MicroSilk)	30
Troubleshooting Using Resistance	32
Ohm's Law	32
Testing a Fuse: Continuity	33
Troubleshooting Heater Resistance	34
Troubleshooting Heater Posts Resistance to Heater Housing	35
Troubleshooting with Voltage	36
Verifying Incoming Voltage at the Terminal Block - BP500, BP2000G1	37
Testing Pump Fuses for Damage with Voltage On - BP2000G1	38
Testing Heater Voltage - All BP Systems	39
A Safer Way to Test Heater Voltages	40
Testing Pump Fuses for Damage with Voltage On - BP500	41
Testing Heater Amperage	42
Testing Low Speed and High Speed at the AMP Pump Connector	43

Component Failure and Replacement Testing	44
Software Setups and Test Mode	44
Setup Changes with DIP Switch 1 ON - BP500.	45
Setup Changes with DIP Switch 1 ON - BP2500	47
Testing the Sensor Set	48
Remove and Replace a System Circuit Board	50
Removing the Heater Assembly from a BP Spa System.	52
TP800, TP900 Panel Operations	54
The Main Screen - Navigation	54
TP800, TP900 Priming Mode Start-up Sequence	55
TP800, TP900 Spa Behavior	56
TP800, TP900 Adjusting Filtration	57
TP800, TP900 Panel Lock & Unlock.	58
TP800, TP900 Sensor and System Related Messages.	59
TP800, TP900 Utilities Menu.	63
TP400, TP600 Standard Panel Operations	64
Main Screen - Navigation	64
TP400, TP600 Panel Utilities Menu	65
TP400, TP600 Preparation and Priming	66
TP400, TP600 Message Codes.	67
TP400, TP600 Utilities Fault Log Menu	70
TP400, TP600 Utilities Menu - GFCI Test Feature	71
TP400, TP600 Simplified vs. Standard Panel Operations.	72
A Simplified Main Menu (Doc No. 42185B)	73
Supplemental Information	74
Optional Balboa Dolphin™ Remote.	74
Spa Guidelines to Keep in Mind	76
Glossary	77
Index	78
Index of Paragraph Topics	83

Service Tools and Parts Checklist

SERVICE TOOLS REQUIRED

- Ammeter (50A) with insulated clamps for probes
- Screwdrivers, assorted flat and Phillips
- Digital Multi-meter
- Padlock (to lock electrical disconnect during service)
- Pliers: Slip Joint & Needle nose
- Precision Thermometer - Digital Fever Type
- Silicone Tube
- Small Wire Cutters
- 3/8" and 1/4" Open End Wrenches (Heater wire nut removal)



FUSES USED ON BP SPA SYSTEMS

Fuse	BWG Part Number
30A	30136
10A	30122
3A Slo-Blo	20600
0.3A Slo-Blo	21581
0.15A Slo-Blo	26281
0.125A Slo-Blo	26397

RECOMMENDED PARTS TO HAVE FOR SERVICE CALLS

- Extra Board(s)
- Extra Panel(s)
- Fuses
- Jumpers
- Heater Assemblies
- Sensor Wires (No. 30344 sensor wire for example).



BP2000 Circuit Board



Heater Assembly

TP Panel Overview and User Guides

TP900



TP800

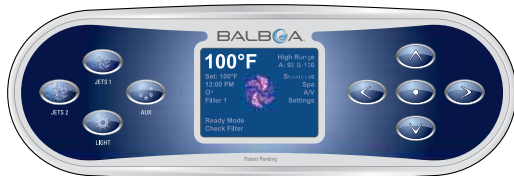

TP600



TP400



System Models: BP2000G1 and other BP-Series Systems as required.

Panel Model: TP900 Series, TP800 Series

Software Version(s): Software versions vary and are constantly changing. See Tech Sheets for latest version and software compatibility.

User Guide **40985**

System Models: BP500 and other BP-Series Systems as required.

Panel Model: TP600 Series, TP400 Series

Software Version(s): Software versions vary and are constantly changing. See Tech Sheets for latest version and software compatibility.

- User Guide **40940**
User Interface and Programming Reference – Standard Menus
- User Guide **42185**; Ref. Card **40947**
User Interface and Programming Reference – Simplified Menus
(See section **TP400, TP600 Simplified Panel Operations** for more information.)

NOTE: All TP panels work with all BP Spa Control Systems. They all have capabilities for navigation, setting functions and modes, such as time, temperature, filter cycles, preferences, sensor related messages, reminder messages, diagnostic messages, and utilities such as fault logs.

Product Identification



On Every System, an Identification Label Is Placed on Top of the Casing



Heater Element Specifications Are Shown on the Heater Tube Label

On Every System, a Wiring Diagram Is Placed Inside the Door

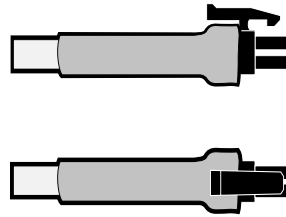

All TP Panels have "Molex" Type Connectors

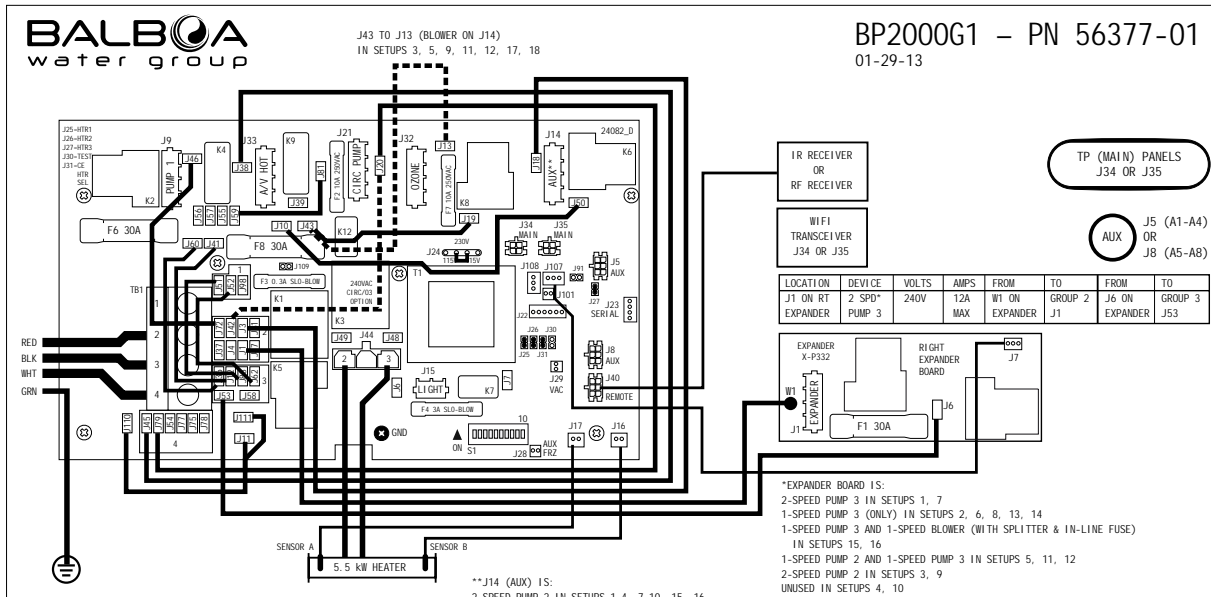
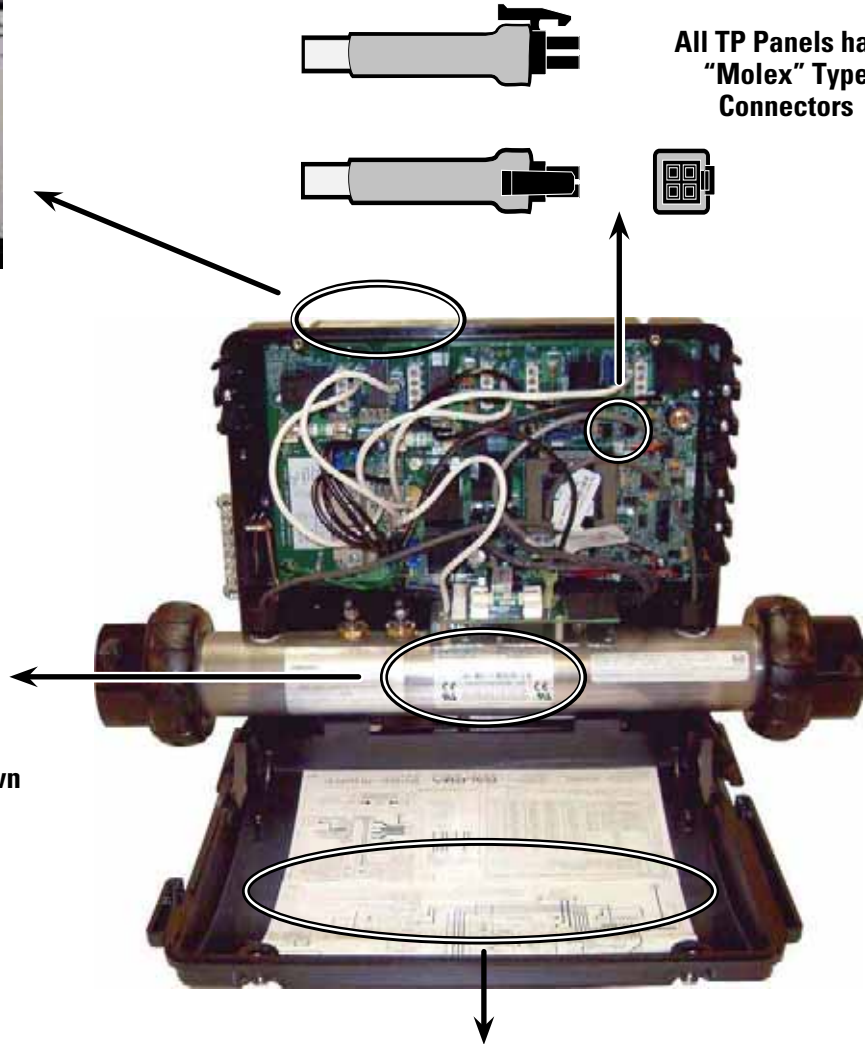

General Troubleshooting & Servicing of Spa's Electrical Equipment

HIGH VOLTAGE CAN SERIOUSLY INJURE OR KILL!

ONLY EXPERIENCED TECHNICIANS SHOULD SERVICE THIS EQUIPMENT.

DO NOT REMOVE THE PROTECTIVE COVERS FROM ANY ELECTRICAL ENCLOSURE, OR ATTEMPT TO SERVICE ANY RELATED ELECTRICAL DEVICE, UNLESS YOU ARE A QUALIFIED ELECTRICIAN OR SERVICE PROFESSIONAL.

DANGER

Risk of electric shock. Before working with any electrical connections, make certain that the Main Power breaker from the house breaker box has been turned off.

WARNING

ALL ELECTRICAL WORK MUST BE PERFORMED BY A QUALIFIED ELECTRICIAN AND MUST CONFORM TO ALL LOCAL CODES.

IMPORTANT

DUE TO THE DANGER OF SEVERE ELECTRICAL SHOCK, LOCATE ALL POWER DISCONNECTS BEFORE SERVICING A SPA. PRECAUTIONS MUST BE TAKEN WHENEVER WORKING WITH BREAKER BOXES, G.F.C.I.'S, OR SERVICE DISCONNECTS.

Always refer to the wiring diagram that is included with each system on the inside of the system box cover. Use this diagram for voltage measurement points, and for proper reconnection of wires.



A terminal marked "GROUND" is provided within the System Control Center enclosure. To reduce the risk of electrical shock, connect this terminal to the grounding terminal of the electric supply panel with a continuous green insulated copper wire equivalent in size to the circuit conductors supplying this equipment, but no smaller than #12 AWG.



Ground in System Enclosure



SAFETY TIPS

- Keep children and pets away.
- Be aware of your surroundings. Standing in water while repairing a spa puts you at serious risk.
- Avoid working in cramped or crowded conditions.
- Consider placing a padlock on the service panel to lock out anyone who might power up the system.

G.F.C.I. Troubleshooting

Keep in mind that a majority of G.F.C.I. tripping problems can be attributed to incorrect wiring. G.F.C.I. troubleshooting usually finds the problem.

IF CORRECT WIRING IS VERIFIED

- Check to see if the proper G.F.C.I. is installed.
- Check the label in the system box near TB1 to determine the maximum amperage draw for the system.
- Be sure the G.F.C.I. is rated for more amperage than the system will draw.
- For a 240 V dedicated system, a 2-pole G.F.C.I. with no load neutral is acceptable.
- For a 120/240 V system, the G.F.C.I. must include a load neutral out.
- If the white load neutral wire is routed from the G.F.C.I. neutral bar directly to TB1 in the system box, then the G.F.C.I. will trip when a 120 V device is activated.
- For a detailed wiring checklist, please review the previous segment of this manual on proper G.F.C.I. wiring or the G.F.C.I. manufacturer's instructions.
- If the wiring is correct and the G.F.C.I. will not reset, then unplug the pump and try to reset the G.F.C.I.
- If the G.F.C.I. trips again, then unplug the blower and reset the G.F.C.I.. If the G.F.C.I. continues to trip, then do the same procedure for the ozone generator.
- If the G.F.C.I. stops tripping after you unplugged one of the spa's components, turn off the power to the spa then plug in each component except the one that tripped the G.F.C.I.
- Power up the system. If the G.F.C.I. no longer trips, then you have correctly identified the problem.
- Repair or replace the component as instructed by the spa manufacturer.
- If you have unplugged all of the spa's components and the G.F.C.I. still doesn't reset, then the problem is most likely a ground fault in the heater.

WARNING: THE OWNER SHOULD TEST AND RESET THE G.F.C.I. ON A REGULAR BASIS TO VERIFY ITS FUNCTION.

TO DISCONNECT THE HEATER

- First, turn off the main circuit breaker, then remove both heater straps or wires from the system heater output, not the heater itself.
- After restoring the power, try to reset the G.F.C.I. again. If it no longer trips after the system calls for heat, then replace the heater.
- If the G.F.C.I. still trips, look for pinched or shorted wires at the transformer. Make sure that the screws that attach the transformer to the system box have not pinched or damaged the insulation of the transformer wires.
- If the transformer wires are undamaged, check for any other pinched wires. Refer to the wiring diagram to verify the correct wiring of the control system.
- If everything looks to be in perfect working order, then the G.F.C.I. may be defective.

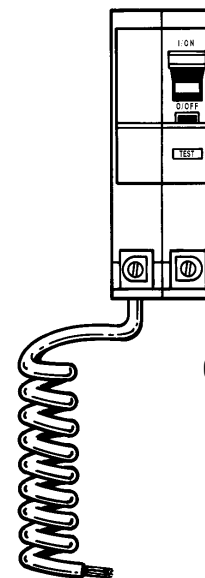

Ground-Fault Circuit Interrupter/Circuit Breaker (G.F.C.I.)

120 Volt Residential Wiring Schematic with G.F.C.I.

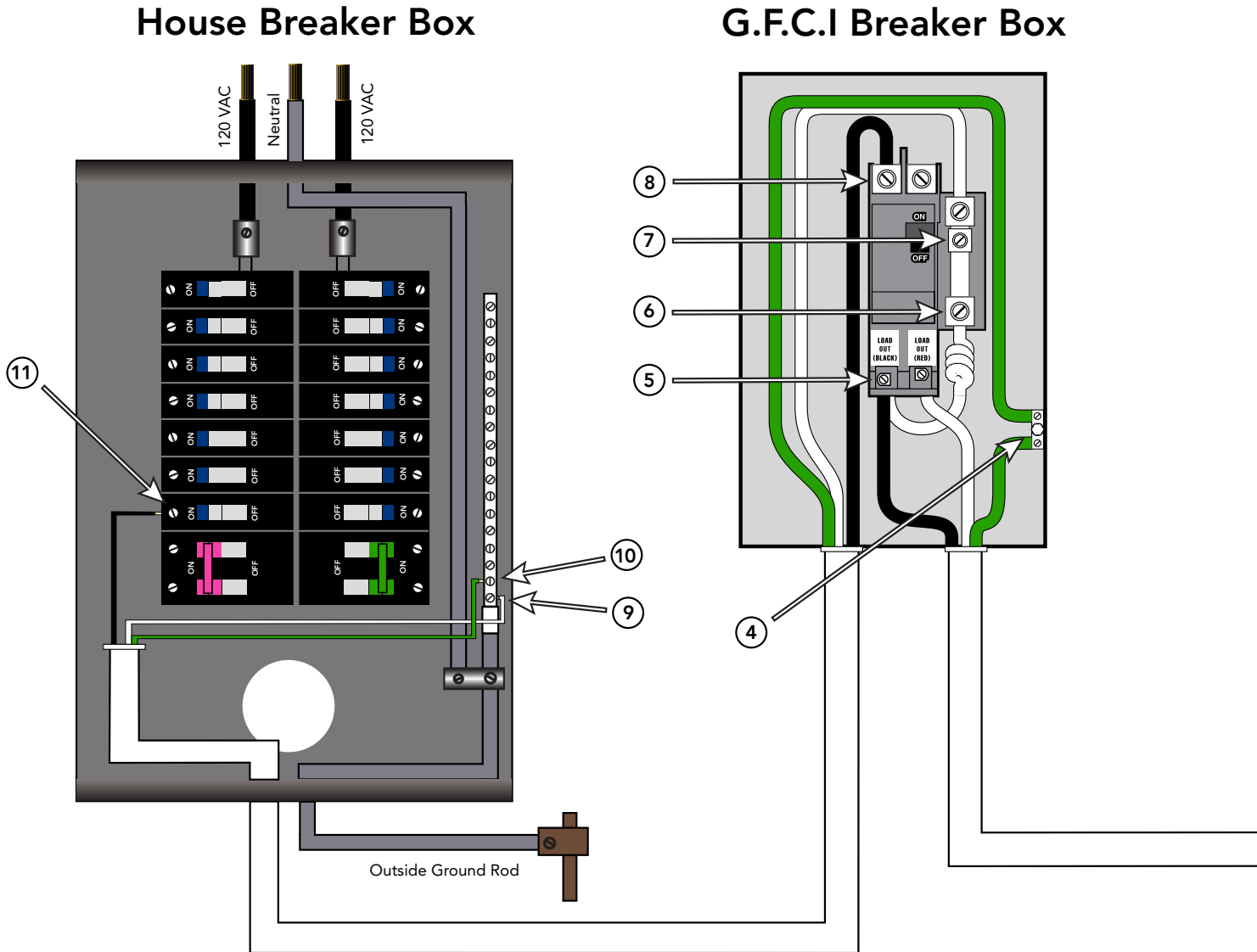

Correct Voltage	When Probes Are Placed Across
0v	[2 - 3] [4 - 6] [4 - 7] [5 - 8] [9-10]
108V - 132V	[1 - 2] [1 - 3] [4 - 5] [4 - 8] [5 - 6] [5 - 9] [6 - 8] [7 - 8] [9 - 11][10 - 11]

**Note: This applies to all Domestic BP Systems.
A BP2000 System is shown for illustrative purposes.**

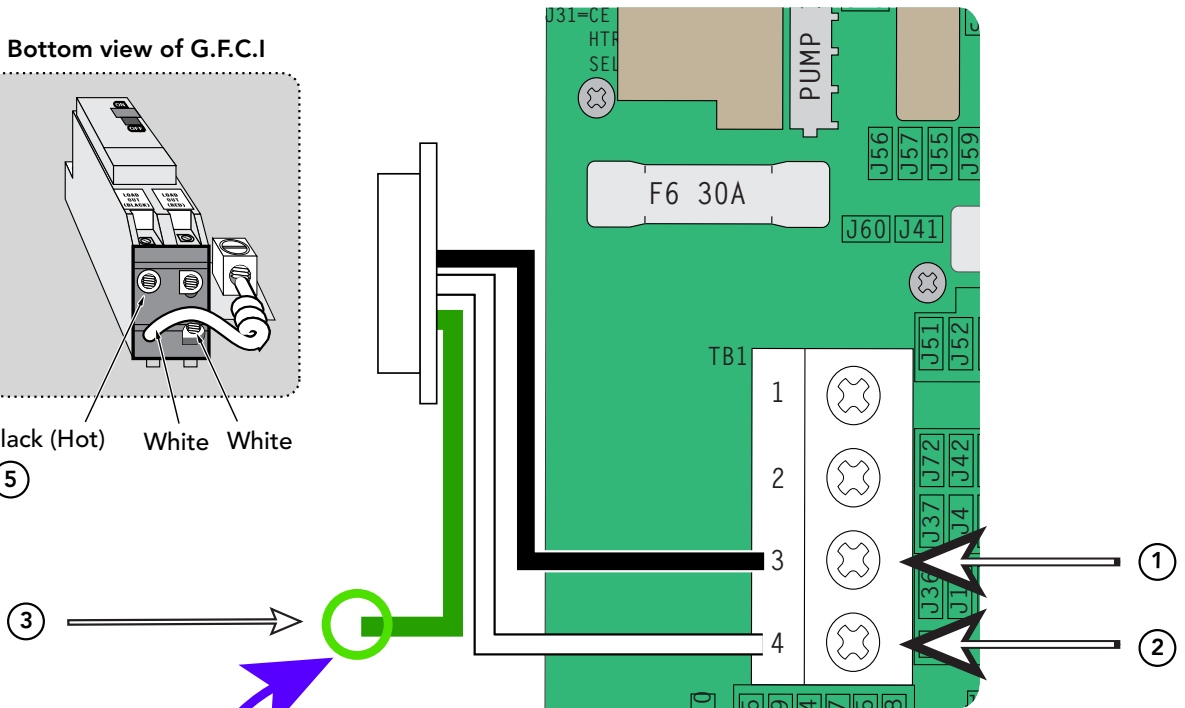
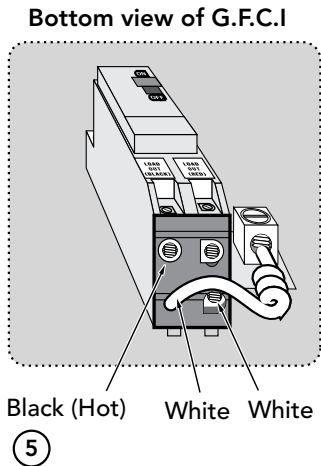

Green Ground Wire to Ground Bar

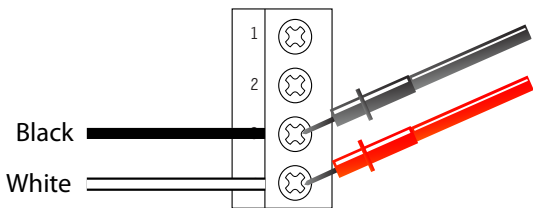
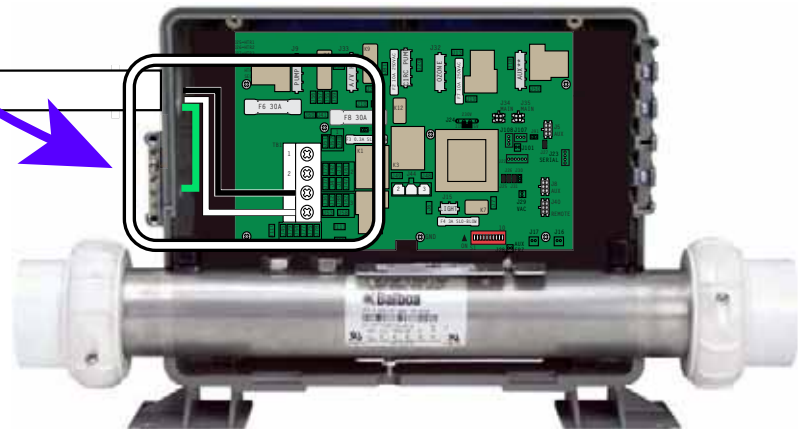

Test for Voltages by placing probes on these locations

240 Volt Residential Wiring Schematic with G.F.C.I.

House Breaker Box

G.F.C.I. Breaker Box

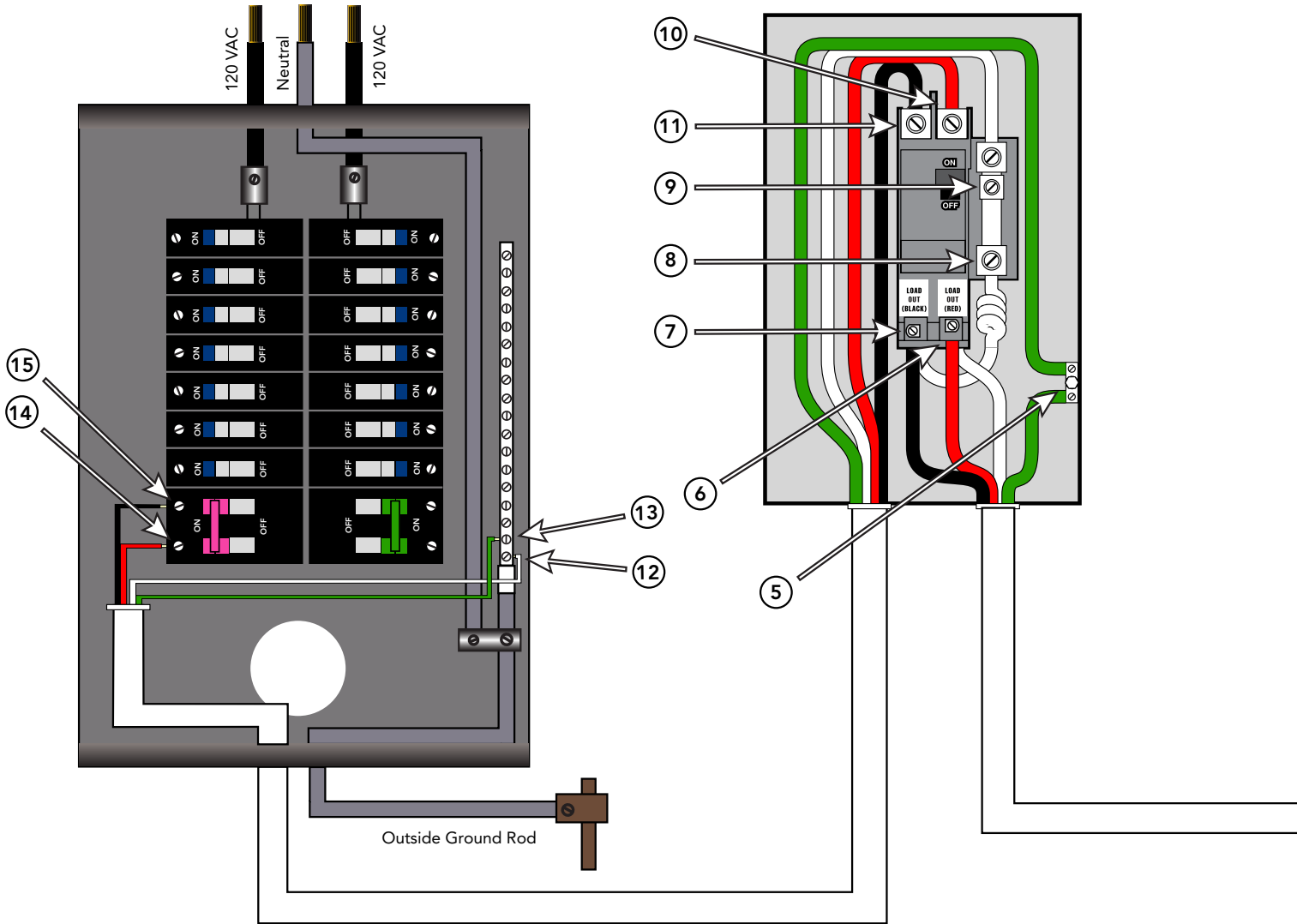

Correct Voltage	When Probes Are Placed Across
0v	[3 - 4] [5 - 8] [5 - 9] [12 - 13]
108V - 132V	[1 - 3] [5 - 6] [5 - 10] [12 - 14] [13 - 14] [2 - 3] [5 - 7] [5 - 11] [12 - 15] [13 - 15]
216V - 264V	[1 - 2] [6 - 7] [10 - 11] [14 - 15]

**Note: This applies to all Domestic BP Systems.
A BP2000 System is shown for illustrative purposes.**

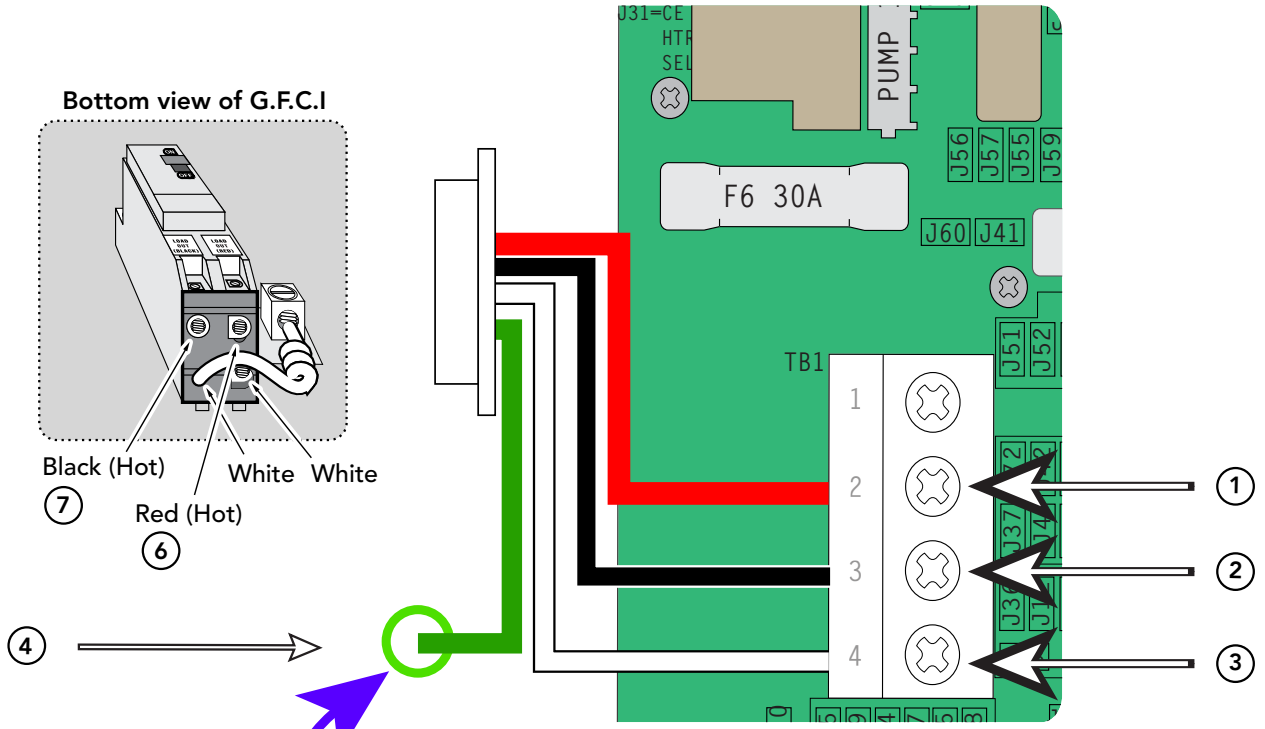
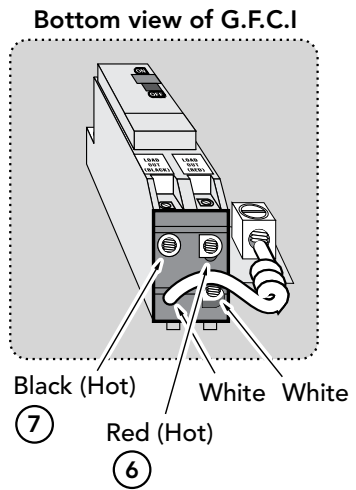

**Green Ground Wire
to Ground Bar**

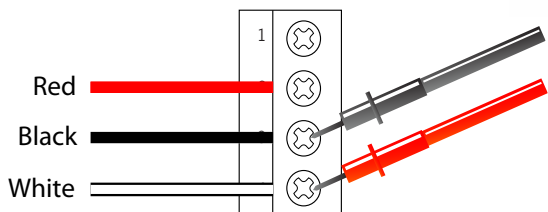
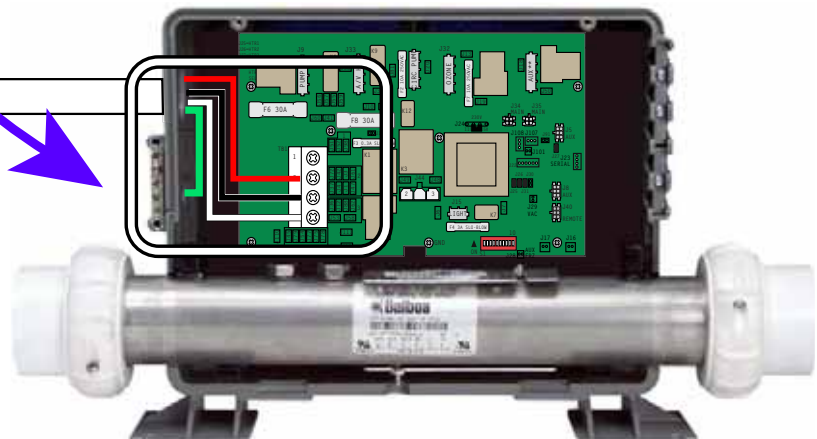

Test for Voltages by placing probes on these locations

Voltage Checks: Breaker Box, G.F.C.I. & System Box

- When checking for proper voltage, keep in mind that the acceptable voltage range is +/- 10% of the recommended voltage.
- Acceptable voltage when 120 V is specified is between 108 and 132 V.
- Acceptable voltage when 240 V is specified is between 216 and 264 V.
- Diagrams are on the following pages.

VOLTAGE VERIFICATION - MOST G.F.C.I. PROBLEMS ARE DUE TO LOW VOLTAGE



IMPORTANT:

IF THE VOLTAGE IS NOT WITHIN THE ACCEPTABLE RANGE, CALL AN ELECTRICIAN OR THE LOCAL ELECTRIC COMPANY TO DIAGNOSE THE PROBLEM.

CHECK THE VOLTAGES AT:

1. Breaker Box Voltage Check
2. G.F.C.I. Line-In Voltage Check.
3. G.F.C.I. Load Out Voltage Check
4. System Box Check At Tb1

120 Volt Systems - 120V ± 10% - 108V - 132V

240 Volt Systems - 240V ± 10% - 216V - 264V

No More Than 2% (5 Volt AC) Difference Between Voltage at the Breaker Panel And Voltage at the System.

CHECK UNDER PEAK LOADS -- TWO TYPES OF PEAK LOADS

1. Spa System Peak Loads - Pumps, Heater, Blower & Light On
2. Household Peak Loads - May Be In Afternoon On Hot Day
Use Recording Meter If Possible - Records Max & Min Volts

• **MIDSTREAM CONTROL SYSTEM RELATED ISSUES**

Communication Between Topside & System Board In Most Systems

Press Button - Message Sent To System Board

System Board Performs - Message Sent Back To Topside & Relay Opens or Closes

LED or Icon Is Turned On or Off - Hear Or See Relay Open Or Close

In Most Cases, If This Happens, There Is No Problem With The Topside Panel or System Board

• **EXAMPLE - SPA LIGHT IS NOT WORKING - 2 OR 3 EASY STEPS !**

1. Press Light Button
Light LED or Icon Turns ON, But Spa Light Is NOT ON
Topside & Board Are Good, Check Downstream
Light LED or Icon Is NOT ON
Topside Or System Board May Be Bad, Continue
2. Plug In Spare Topside Panel - Easier To Check For Bad Topside
Light LED or Icon Now Turns ON
Original Topside Is Bad - R&R Topside Panel
Light LED or Icon Is NOT ON
Original Topside Is Good, Do Not Replace
System Board Is Bad - R&R System Board
3. Spa Light Is Still NOT ON - Check Downstream
Same Procedure For Other Functions
Jets, Blower, Heater, Time, Program, Mode, etc.

Wiring Checks

WIRING CHECK PRECAUTIONS

- When working in a system box always be aware that it may contain high voltage.
- Always keep your fingers and hand tools away from any wiring or circuit board when the power is on. Touching anything in these areas can result in serious injury.
- All service calls, no matter how minor, should include a complete wiring check, beginning with the house breaker.

CHECK FOR LOOSE CONNECTIONS OR DAMAGED WIRES

- Make sure the power is off before you touch any wiring.
- Once the power is off, carefully examine all wires for cuts or defects.

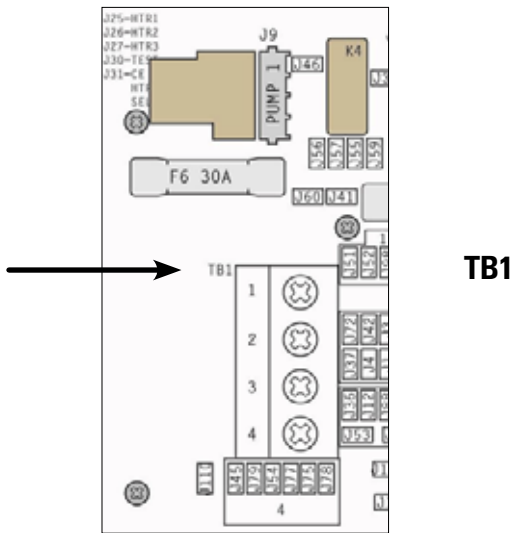

SYSTEM BOX WIRE GAUGE CHECK

When inspecting the wiring for any control system, note that connections for the incoming wires are clearly labeled at the main terminal block.

- 30A service – minimum ten gauge copper wire.
- 40A service – minimum eight gauge copper wire.
- 50A service – minimum six gauge copper wire.

These wires must connect the house breaker box, through the local disconnect, to the main terminal block. The wiring diagram inside the system box shows the main terminal block as TB1.

IMPORTANT

Using non-copper wire can be dangerous, and also can be the cause of a spa's malfunction. If non-copper wire is used at any point, we do not recommend servicing the spa until an electrician replaces it with the proper gauge copper wire.

IMPORTANT

This service must be single phase. Any abnormal voltage reading requires an electrician. Do not attempt to fix these types of problems yourself. High voltage can seriously injure or kill.

TOTAL Ampere Rating of Power System	Minimum wire size Use Copper ONLY, with 90 ° C insulation	Ampere Rating of G.F.C.I. Circuit-breaker
0 A to 16 A	#12 AWG	20
16 A to 20 A	#10 AWG	25
20 A to 24 A	#10 AWG	30
24 A to 28 A	#8 AWG	35
28 A to 32 A	#8 AWG	40
32 A to 36 A	#6 AWG	45
36 A to 40 A	#6 AWG	50

Testing a System with Power

LOW VOLTAGE

At Balboa, it's been our experience that the majority of the problems associated with electronic control systems are due to low voltage.

BROWN OUTS

"Brown outs" can have an effect on the spa's operation in a variety of ways. The control panel may go blank, have scrambled messages on the LCD, or only a few features will function.

CHECKING THE SYSTEM POWER INPUT FUSE



WARNING

THESE PROCEDURES ARE PERFORMED WHILE THE SYSTEM IS POWERED UP AND RUNNING UNDER PEAK LOADS.

If the system is getting the proper voltage at TB1, but still doesn't operate, then test for a blown power input fuse.
(See section: Testing Pump Fuses for Damage)

- Measure between the white TB1 terminal and power input fuse. You should see 120 volts.
- If the system is equipped with the additional power input fuse, measure additional power input fuse in the same manner. You should also see 120 volts.

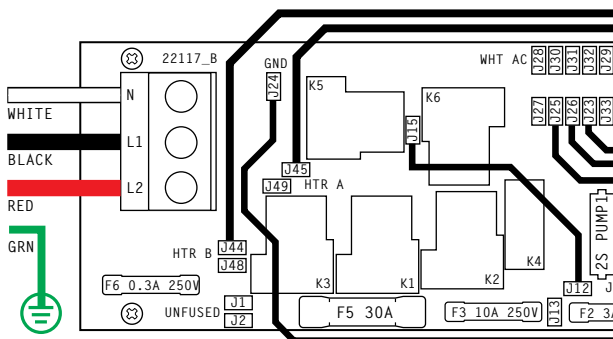

Terminal Block 1 & F5 Fuse on a BP500 Power Board, 240V Setup

If your system uses 240V peripheral devices (below):

- Measure between the red TB1 terminal and power input fuse. You should see 240 volts. Measure the other side of the input fuse. You should also see 240 volts.
- If you determine that there is no voltage at both locations, then the system power input fuse needs to be replaced. Only use a fuse of the same type and amp rating when you replace any fuse.
- **NOTE FOR ALL SYSTEMS:** In each situation, the most likely reason for the system power input fuse to blow is a pump problem. However, on occasion, a blower problem may also cause this fuse to blow if a 10A blower fuse is not built in.

Once the power input fuse has been changed

- Probe the red wire and the white neutral wire. Again, voltage must be between 108 and 132 V.
- Check the voltage between the black and red wires again. Acceptable voltage range is between 216 and 264 V.

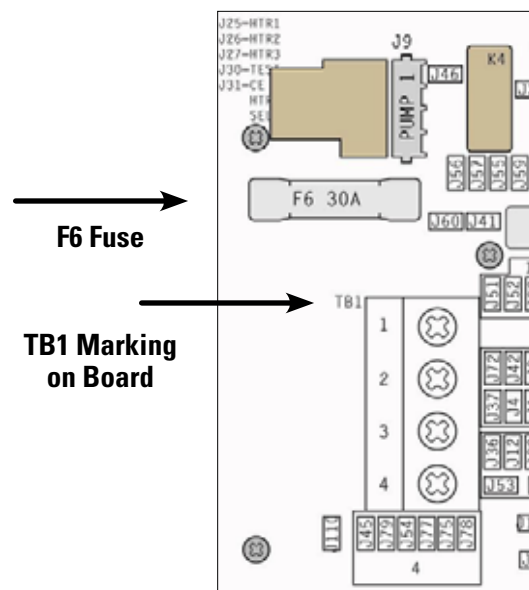

Terminal Block 1 & F6 Fuse on a BP2000 Board

Testing a System with Power (cont.)

THESE READINGS SHOULD BE TAKEN UNDER PEAK LOAD CONDITIONS.



IMPORTANT

If the voltage is not in the acceptable range, call an electrician or the local electric company to diagnose the problem.

TO DETERMINE THE CAUSE OF A BLOWN POWER INPUT FUSE

Perform the following *sequence of tests*.

Test the System

- Turn the power off.
- Be sure to replace the system power input fuse with the same type.
- Unplug the blower and all pumps.
- Restore the power and verify system operation.
- If the fuse blows, power down the system and then re-check the internal system wires and connector for burns, cracks or cuts in insulation.
- Or, if the fuse does not blow, turn the power off and plug in the pump.

NOTE: Be sure to test each device individually.

Test the Pump

- Restore the power and activate the pump.
- If the fuse blows, there is a pump problem.
- If the fuse does not blow, turn off the power.

Test the Blower

- Plug in the blower.
- Power up the system and activate the blower.
- If the fuse blows, then there is a blower problem.
- If the fuse does not blow, the combined pump and blower amperage may be excessive. To verify this, first check with your spa manufacturer for amperage draw limits on each device.
- Since the blower should now be running, you can check the amperage draw with an ammeter by measuring around the black blower wire and compare with manufacturer's specifications.

TEST THE AMPERAGE DRAW

- Turn off the power, disconnect the blower, make sure the pump is plugged in, and restore power.
- Start the pump and switch to high speed (if available), this should draw the most current.
- Make sure all jets and valves are open.
- Check the amperage at the red pump wire. Compare your reading with manufacturer specifications. (If the other plug-in devices exist, they should be tested in the same way.)
- If the amperage draw for each device is within manufacturer's specifications, the problem could be a nuisance spike in the pump, or water in the blower.



NOTE: These slow-blow fuses are not always discolored when blown. Always test continuity of a fuse with an ohmmeter.

NOTE: Miswiring of the spa is the most common reason for this fuse to blow. However, a lightning strike in the area is a possible, though less likely, cause of the failure.

ELECTRICAL PROTECTION

1. Local Disconnect:
A local disconnect (sometimes referred to as an "electrical disconnect") is installed apart from the main service panel. The local disconnect must be installed where readily accessible and within sight of the spa, but at least 5' (1.5 meters) from the inside wall of the spa.
2. GFCI:
It is required by code to install a Ground Fault Circuit Interrupter (GFCI) in the supply power for a spa.

NOTE: A GFCI power cord is included with a 120VAC spa. This can be used for a cord-connected 120V setup only, and only in place of a stand-alone GFCI.

Testing a System with Power (cont.)

See manufacturer's owners manual or reference card for general information on operating the spa, including programming filters and other settings that are changed from the topside control panel.

SAFETY AND ELECTRICAL SYSTEMS

- Use minimum 6AWG copper conductors only.
- Torque field connections between 21 and 23 in-lbs.
- Connect only to a circuit protected by a Class A Ground Fault Circuit Interrupter (GFCI) CSA enclosure: Type 2.
- The BP Spa Control Systems are classified as a "continuous duty appliance" and is intended primarily for installation at a single family dwelling. The installation recommendations and instructions contained in this manual are directed solely toward these issues.

WARNING!

If there is any doubt whether the system that you are installing into does not have these features, contact a licensed, qualified electrician. **Do not attempt to modify the wiring yourself.**

HEATER START UP INFORMATION

On M-7 systems, the heater goes through a testing phase every time it starts up to assure that there is adequate water flow. This provides sophisticated dry fire and low flow protection. It can be confusing if you don't know what to expect. Step by step, here is what happens. (Note that the timing/temperature details may be slightly different on some older M7 systems.)

- Prior to heating, the pump is run for at least two minutes, and then the temperature difference between the sensors is assessed. It must be 2°F/1.0°C or less for heating to proceed, otherwise an error is issued.
- The heater turns on for 6.5 to 18 seconds (depending on heater voltage and wattage). At this point, the heat indicator on the panel is "solid". During this time the panel is not immediately responsive.
- The heater turns off for 90 seconds, making sure that the water flow keeps the temperature rise small and short. (Abnormal water flows, or lack of water, will produce a large and/or long temperature rise, and the system faults in that situation.) At this point, the heat indicator on the panel may appear to "shimmer" or "dim" (on some panels this may be less obvious from certain angles and more obvious from other angles, or in different lighting).
- If the dry fire test has passed, heating turns back on to heat the spa. The heat indicator on the panel returns to "solid".
- During spa heating, a difference between the sensors of 2°F/1.0°C, or perhaps 3°F/1.5°C (at least with 4-6kW 240V heaters), is considered normal. A significantly higher difference, however, is usually indicative of a flow problem, and will cause a fault which disables the heating for at least a minute (and then restarts the whole above process).

PRELIMINARY PANEL CHECK

- If the problem is not obvious, look on the topside control panel for diagnostic messages.
- If no messages are seen, run through all spa functions and note any inconsistent operation.
- Most error messages are stored in the fault log. To view the fault log, the spa must be in test mode and the spa light must be turned on.

Once you have determined that proper voltage is running through the circuit board and transformer, continue to the topside control panel. A panel that is not functioning properly may include the following symptoms: low voltage such as missing or scrambled segments, missing icons on the LCD, non-functional LED's, or nonfunctional buttons. If any of these symptoms are present, perform the following:

- Turn the power off and unplug the panel from the circuit board.
- Then, plug in your test panel and restore power. If everything functions normally, replace the topside panel.
- Disconnect ozone generator (if applicable).
- If you still see symptoms of low voltage, such as a sluggish, blank or partially blank panel, or if the display or the LED's do not function at all, turn the power off; unplug the ozone generator (if equipped); then restore power to the system. If the problem persists, turn off the power and replace the circuit board.

FLASHING HEAT LED ON TP600 ("HEAT WAITING")

When there is a call for heat, the system will start the heater for a few seconds and the Heat LED will light. After a few seconds of heat, the heater will shut off for 90 seconds and the system will look at the sensors to be sure they are within the M7 parameters for flow and a safe environment to run the heater. During this 90 second wait time, the Heat LED will flash quickly, or "shimmer", until the heater comes on again to heat. There is no voltage to the heater during this cycle. This is normal for M7. Once the heater comes back on, the LED will be on without shimmering. On the TP800 and TP900 panels, the screen will display "Heat Waiting".

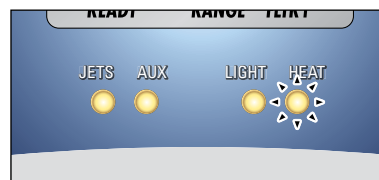

Heat LED in Heat Waiting Mode, TP600

Testing a System with Power (cont.)

MOST PROBABLE OVERHEATING CAUSES, INSPECT THESE FIRST

- Check slice or ball valves. Make sure that they are open.
- Make sure the correct pump is installed.
- Clean the filter/skimmer if there is any blockage.
- Check heater element alignment.
- Check for debris on the heater element.
- In extremely hot weather, check for proper cabinet ventilation.
- Make sure the temperature sensor is fully inserted into the sensor fitting on the heater.
- Check for excessive filter duration.
- Check the water level.
- Check the water temperature with an accurate temperature thermometer. Remove the spa cover and allow the water to cool to below 108° F. Adding cool water may be necessary. Touch any button to reset the system. If the water is still hotter than the set temperature, press the blower button (if applicable) to cool the spa.
- If the Problem Recurs, test the Sensor Set.

NOTE:

A common programming mistake is overlapping filter times that may cause the spa to filter continuously.

If alternating with temperature, it may just be a temporary condition. If flashing by itself, spa is shut down. If the panel also displays "Service Req" spa is shut down. If the spa shuts down due to this error, one (or both) of the sensors are probably reading several degrees off. If the problem recurs, test the sensor set.

FREEZE CONDITION

When either sensor reads below 40°F (4°C), the system provides freeze protection. It automatically activates the pump (and the heater if necessary) to circulate the water and warm the plumbing. The equipment stays on until the sensors detect that the spa temperature has risen to within 15°F of the set temperature. The other pumps and the blower will purge for 30 seconds to 2 minutes at the end of the freeze condition. If pump 1 was turned on due to this reason alone, this message will appear for up to two minutes right after very cold water is detected.

NOTE: Internal freeze protection only functions when there is proper power running to the spa, and the control system is operational. Using an optional freeze sensor may be necessary in extreme climates to prevent plumbing damage, but will only

work properly if placed inside the spa skirt in the coldest area. All spa models are different in shape and size and have different thermal characteristics; therefore, Balboa Water Group cannot be held responsible for freeze damage to the spa's plumbing. Testing is the responsibility of the spa manufacturer and must be done to determine the best location for the freeze sensor.

SOME TROUBLESHOOTING SCENARIOS

You find out the system is in "OHH". This alone doesn't explain a lot. What led up to the "OHH" is much more important. If it's a Prestige, review the fault log carefully. Otherwise, see if the user has any additional information (for example, how long before the "OHH" was the spa panel last checked, and how hot was the water then). If the spa has cooled, see whether the problem can happen again, this time watching carefully to see if there are additional clues leading to the "OHH" (for example, other messages that appear shortly before the "OHH" happens).

You find out the system keeps showing "HFL," or is now in "LF," or is shut down due to a "dry" fault. Put the spa in test mode with the light on, so that you see the two sensor temperatures. Are they normal (within 1°F/0.5°C) when not heating? How far apart are they when heating? "HFL" happens when they are 6°F/3°C apart (4°F/2°C on 120V and other low-heater-wattage systems), see how quickly that happens after heating starts. If it's getting close to that right away, it's probably a consistent flow problem, but if it's nowhere close to the "HFL"-causing temperature difference, the flow problem may be intermittent or only occur in certain specific situations.

TEST MODE

Test modes vary for different systems and configurations. Please refer to the specific Tech Sheet applicable.

MESSAGE CODES

Refer to Tech Sheets for each system code. Or, a general set of codes for BP systems is found under the section *TP400, TP600 Message Codes* in this manual. Message codes are the same for all TP panels.

Troubleshooting Pumps, Problem & Cause

Cause	Problem	Pump motor does not start	Pump will not turn off	Pump not pumping properly	Jets not fully functioning	Low water pressure / flow	Water leakage f/ unions	No air mixed into water	Contact qualified electrician for service	Pump hums, noisy
GFCI / Fuse		X							X	
No incoming power		X							X	
Thermal overload tripped										
Air button, or switch on pump defective		X	X						X	
Air tube blocked, kinked, or dislodged		X	X						X	
Jets are closed				X	X				X	
Leaks / loss of prime				X					X	
Low voltage; is there proper voltage?				X					X	X
Motor burnt, flooded by water		X							X	
Open air control valves								X		
O-ring over / under tightened, pinched, improperly seated							X		X	
Pipe inlet higher than water line				X		X			X	
Pump jammed with debris		X		X		X			X	X
Pump not installed at correct level				X	X				X	
Suction cover/guard, impeller, or filter may be clogged				X	X	X			X	X
Water level too low				X	X					
Bearings bad									X	X

Acceptable Ranges for Testing Equipment

VOLTAGE CHECKLIST

All voltages specified as 120 V or 240 V, may show an acceptable variance of +/- 10%.

Voltage Ranges

Wire Combo	Voltage	+/- 10% Range
Black & Red	240 V	216 V -264 V
Black & White	120 V	108 V -132 V
Red & White	120 V	108 V - 132 V
Black& Green	120 V	108 V - 132 V
Red & Green	120 V	108 V - 132 V
Green & White	0 V	* *

* Depending on variables such as length of run, type of wire and temperature, small voltage readings may sometimes occur between ground and neutral.

MOTOR AMPERAGE GUIDELINES

The following ranges represent general parameters for many different motors and applications. Check the device label or with the spa manufacturer to get accurate amperage draws.

AMPERAGE DRAW RANGES

DEVICE	120V DRAW	240V DRAW
Pump low	2 A - 5 A	2 A - 4 A
Pump high	10 A - 14 A	8 A - 12 A
Blower	6 A - 8 A	3 A - 4 A

ACCEPTABLE HEATER AMPERAGE DRAW RANGES

Heater Type	120V Amp Draw	240V Amp Draw
5.5 kW @ 240 V	10.42 A - 12.74 A	20.83 A - 25.48 A
4 kW @ 240 V	7.58 A - 9.26 A	15.15 A -18.52 A
1 kW @ 120 V	7.58 A - 9.26 A	-

ACCEPTABLE HEATER OHM (Ω) RANGES

Heater Type	Ohms (Ω)
5.5 kW @ 240 V	9.42 Ω -11.52 Ω
4 kW @ 240 V	12.96 Ω -15.84 Ω
1 kW @ 120 V	12.96 Ω - 15.84 Ω

TEMPERATURE & HIGH-LIMIT SENSOR OHM TABLE

Temp. of Sensor	Ohms (kΩ)**	Temp. of Sensor	Ohms (kΩ)**
40° F	76.686 kΩ	90° F	22.117 kΩ
45° F	67.112 kΩ	100° F	17.636 kΩ
50° F	58.858 kΩ	105° F	15.788 kΩ
60° F		110° F	14.158 kΩ
70° F	35.533 kΩ	115° F	12.716 kΩ
80° F	27.93J kΩ	120°F	11.439 kΩ

**Note: 1 kΩ = 1000 Ω :

kΩ may vary +/- 10% depending on the accuracy of the thermometer and meter used.

HEATER MATRIX

Heater Type	Ohms	120V Amp Draw	120V Watts	240V Amp Draw	240V Watts	230V Amp Draw	230V Watts
5.5Kw @ 240V	10.472	11.458	1.37Kw	22.916	5.5Kw	21.961	5.05Kw
5.2Kw @ 240V	11.076	10.834	1.3Kw	21.666	5.2Kw	20.765	4.8Kw
4Kw @ 240V	14.4	8.333	1Kw	16.666	4Kw	15.972	3.7Kw
3Kw @ 240V	19.2	6.25	750W	12.5	3Kw	11.979	2.8Kw
2Kw @ 240V	28.8	4.166	500W	8.333	2Kw	7.986	1.8Kw
1Kw @ 120V	14.4	8.333	1Kw	N/A	N/A	N/A	N/A

Fuses: Devices, Locations, and Values

Fuses:
BP500 series (UL),
BP600 Series (CE)

Fuse	Fuse Current Rating	Protects device on output #	Device - depending on system set up	
F2	3A 250VAC	J22	Ozonator	
F3	10A 250VAC	J14 (option)	Blower fuse only. Jumped out for Pump 2.	
F4	3A 250VAC	J15	Spa Light	
F5	30A, Class G, 250V	All, Except Heater	Input power (Line 1)	
F6	0.3A, Slo-Blo	BP500 (UL)	120VAC Transformer Input	
F6	0.15A, Slo-Blo	BP600 (CE)	230VAC Transformer Input	

Fuses:
BP2000 series (UL),
BP2100 series (CE)

Fuse	Fuse Current Rating	Protects device on output #	Device - depending on system set up	
F2	10A 250VAC	J32, J21	Ozonator, Circ Pump	
F3	0.3A Slo-Blo	BP2000 (UL)	120VAC Transformer Input	
F3	0.125A Slo-Blo	BP2100 (CE)	230VAC Transformer Input	
F4	3A Slo-Blo	J15	Spa Light	
F6	30A	J9, J33	Pump 1, AV (Audio), .250 spades	
F7	10A	J14	Blower fuse only. Jumped out for Pump 2.	
F8	30A	Typically J14	Floating - Typically J14 (P2, Blower, etc.)	
F1	30A	J1	Pump 2, Pump 3, Microsilk, etc.	On Expander Board
	Fuse	BWG Part Number		
	30A	30136		
	10A	30122		
	3A Slo-Blo	20600		
	0.3A Slo-Blo	21581		
	0.15A Slo-Blo	26281		
	0.125A Slo-Blo	26397		

BP 60Hz Spa Control System Wiring Diagrams

Wiring Diagram - BP500, Part Number 56278, Setup No. 1 (as manufactured)

Power Requirements:

240VAC, 60Hz, 40A, Class A GFCI-protected service (Circuit Breaker rating = 50A max.)
4 wires (Hot-Line 1, Hot-Line 2, Neutral, Ground)

System Outputs:

Pump 1	240VAC	2-Speed	12A max	30-minute timer for Low Speed, 15 Minutes for High Speed
				This is the heater pump and must be the same voltage as the Ozone
				Must deliver a minimum of 20 GPM through heater
Pump 2	240VAC	1-Speed	12A max	15-minute timer
Ozone	240VAC		.5A max	Uses the same relay as Pump 1 Low
				Must be the same voltage as heater pump
Spa Light	12VAC	On/Off	1A max	4-Hour timer.
Heater	4kW @ 240VAC			
Misc.	J23 & J32	120VAC	4A max	Hot output (Stereo). Fused equipment or in-line fuse required.

Wiring Diagram and Settings

ON POSITION	S1 SWITCH #	OFF POSITION
MEMORY RESET*	6	STORE SETTINGS*
SPECIAL AMPERAGE RULE ON	5	SPECIAL AMPERAGE RULE OFF
ADD 4 HS PUMPS WITH HEAT	4	DON'T ADD 4 HS PUMPS W/HTR
ADD 2 HS PUMPS WITH HEAT	3	DON'T ADD 2 HS PUMPS W/HTR
ADD 1 HS PUMP WITH HEAT	2	DON'T ADD 1 HS PUMP W/HTR
TEST MODE ON	1	TEST MODE OFF

*SWITCH # 6 SHOULD BE SET TO OFF UPON FINAL INSTALLATION.



WS01

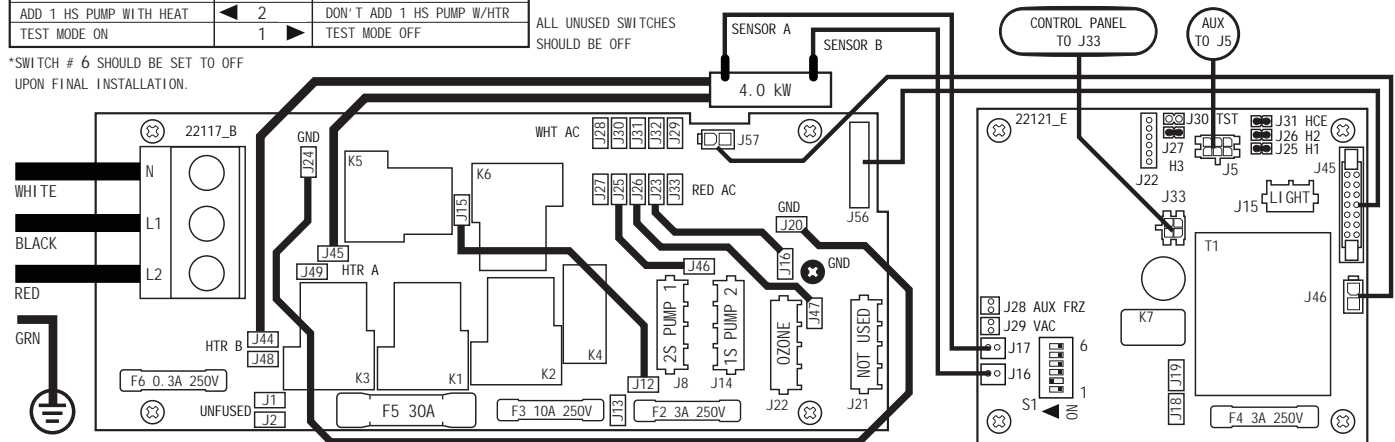

Wiring Diagram - BP2000G1, Part Number 56377

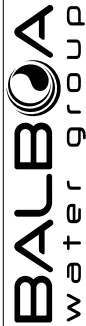

BP2000G1 - PN 56377
10-23-12

J43 TO J13 (BLOWER ON J14)
IN SETUPS 3, 5, 9, 11, 12

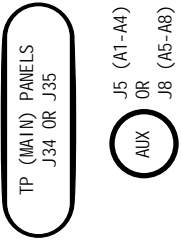
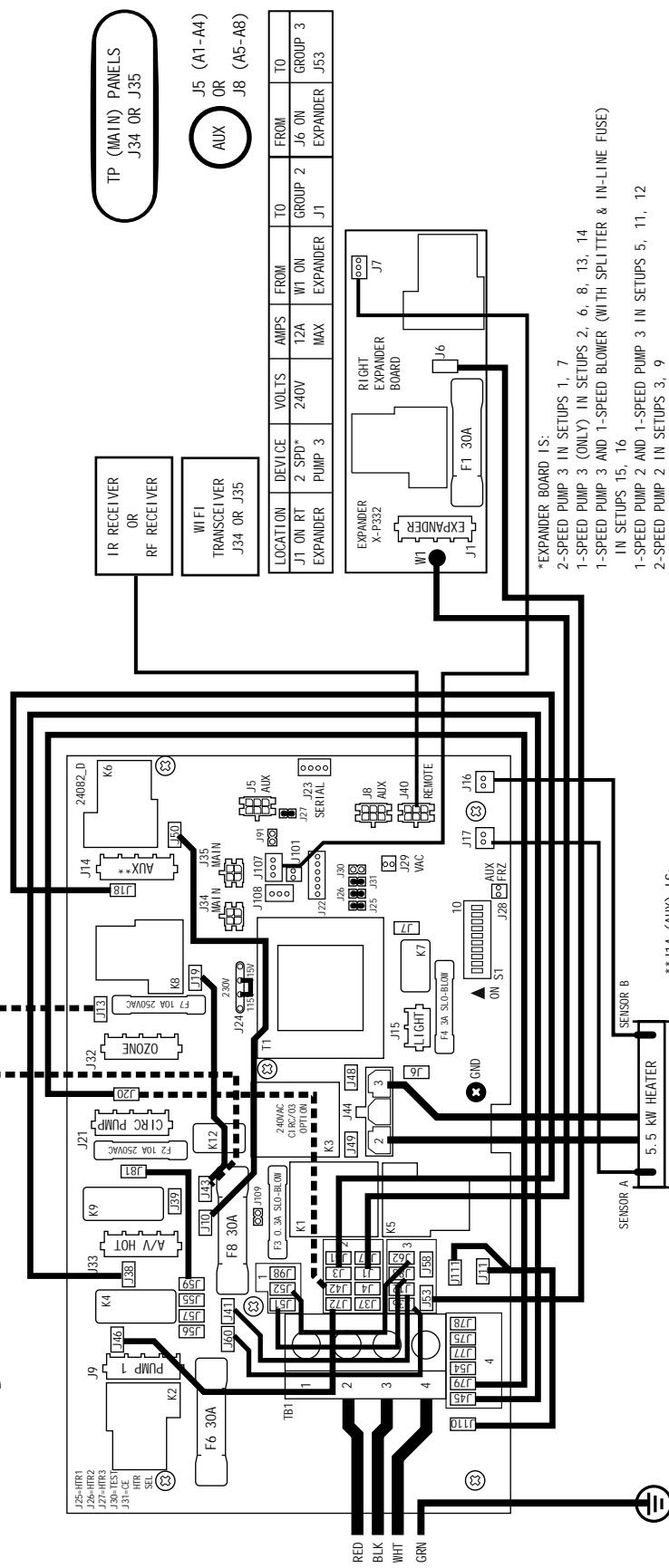

LOCATION	DEVICE	VOLTS	AMPS	FROM	TO
J1 ON RT EXPANDER	2 SPD* PUMP 3	240V	12A MAX	W1 ON EXPANDER	GROUP 2 J6 ON EXPANDER
J1 ON RT EXPANDER	PUMP 3	240V	12A MAX	W1 ON EXPANDER	GROUP 3 J6 ON EXPANDER

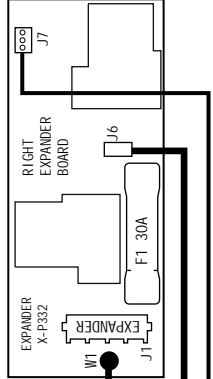

- *EXPANDER BOARD IS:
- 2-SPEED PUMP 3 IN SETUPS 1, 7
 - 1-SPEED PUMP 3 (ONLY) IN SETUPS 2, 6, 8, 13, 14
 - 1-SPEED PUMP 3 AND 1-SPEED BLOWER (WITH SPLITTER & IN-LINE FUSE) IN SETUPS 15, 16
 - 1-SPEED PUMP 2 AND 1-SPEED PUMP 3 IN SETUPS 5, 11, 12
 - 2-SPEED PUMP 2 IN SETUPS 3, 9
 - UNUSED IN SETUPS 4, 10

- **J14 (AUX) IS:
- 2-SPEED PUMP 2 IN SETUPS 1-4, 7-10, 15, 16
 - 1-SPEED PUMP 2 IN SETUPS 5, 6, 11-14
 - 1-SPEED BLOWER IN SETUPS 3, 5, 9, 11, 12

PART A

Wiring Diagram – BP2000G1, Part Number 56377 (cont.)

LOCATION	DEVICE	VOLTS	MAX AMPS	FROM	TO
J9	2-SP PUMP 1	240V	12A MAX	J46	J72-GROUP 2
J14	AUX	240V	12A MAX	J18	J3-GROUP 2
J15	AUX LINE 1 CONNECTION	J19	J43		
J21	SPA LIGHT	12V	1A	J20	J79-GROUP 4
J32	CIRC PUMP	120V*	2A MAX		
	OZONE		1A		
J33	CIRC AND OZONE LINE 1 CONNECTION	J81	J59		
J44	TV / AV	120V	3A	J38	J45-GROUP 4
	HEATER	240V	5.5 KW		

* FOR 240V CIRC PUMP AND OZONE, CONNECT J20 TO J42 (IN GROUP 2)

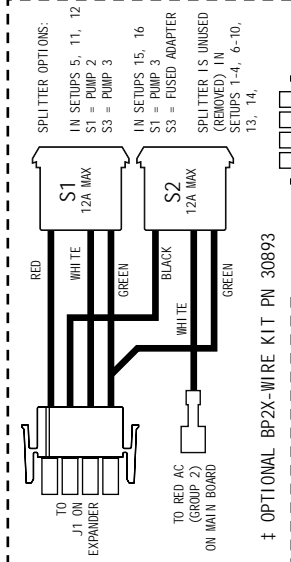

† OPTIONAL BP2X-WIRE KIT PN 30893

SETUP #	CIRC PUMP	PUMP 1	PUMP 2	PUMP 3	BLOWER	TEMP SCALE
1	NONE	2-SPEED	2-SPEED	2-SPEED	NONE	°F
2	NONE	2-SPEED	2-SPEED	1-SPEED	NONE	°F
3	NONE	2-SPEED	2-SPEED	NONE	1-SPEED	°F
4	NONE	2-SPEED	2-SPEED	NONE	NONE	°F
5†	NONE	2-SPEED	1-SPEED	1-SPEED	1-SPEED	°F
6	NONE	2-SPEED	1-SPEED	1-SPEED	NONE	°F
7	PROGRAMMABLE FILTRATION + POLLING	2-SPEED	2-SPEED	2-SPEED	NONE	°F
8	PROGRAMMABLE FILTRATION + POLLING	2-SPEED	2-SPEED	1-SPEED	NONE	°F
9	PROGRAMMABLE FILTRATION + POLLING	2-SPEED	2-SPEED	NONE	1-SPEED	°F
10	PROGRAMMABLE FILTRATION + POLLING	2-SPEED	2-SPEED	NONE	NONE	°F
11‡	PROGRAMMABLE FILTRATION + POLLING	2-SPEED	1-SPEED	1-SPEED	1-SPEED	°F
12‡	PROGRAMMABLE FILTRATION + POLLING	1-SPEED	1-SPEED	1-SPEED	1-SPEED	°F
13	PROGRAMMABLE FILTRATION + POLLING	2-SPEED	1-SPEED	1-SPEED	NONE	°F
14	PROGRAMMABLE FILTRATION + POLLING	1-SPEED	1-SPEED	1-SPEED	NONE	°F
15‡	NONE	2-SPEED	2-SPEED	1-SPEED	1-SPEED	°F
16‡	PROGRAMMABLE FILTRATION + POLLING	2-SPEED	2-SPEED	1-SPEED	1-SPEED	°F

PUMP 1 LOW TIMEOUT IS 15 MINUTES.

‡SETUPS 5, 11, 12, 15 AND 16 REQUIRE BP2X-WIRE KIT PN30893



† INSTEAD OF SETUP #1, THIS SYSTEM IS CONFIGURED IN SETUP #:

SWITCHBANK S1 OFF

TEST MODE OFF	TEST MODE ON
DOWN T ADD 1 HS PUMP W/HTR	A1
DOWN T ADD 2 HS PUMPS W/HTR	A2
DOWN T ADD 3 HS PUMPS W/HTR	A3
DOWN T ADD 4 HS PUMPS W/HTR	A4
SPECIAL AMPERAGE RULE A	A5
STORE SETTINGS**	A6
1 MIN HTR COOLDOWN (ELEC)	A7
NOT ASSIGNED	A8
NOT ASSIGNED	A9
NOT ASSIGNED	A10

** SWITCH # 6 SHOULD BE SET TO OFF UPON FINAL INSTALLATION.

USE COPPER CONDUCTORS ONLY.
EMPLOYER UNIFORMEMENT DES CONDUCTEURS DE CUIVRE.
#6 AWG MIN. WIRE = 90°

FOR SUPPLY CONNECTIONS, USE CONDUCTORS SIZED ON THE BASIS OF 60°C AMPACITY BUT RATED MINIMUM OF 90°C.

TORQUE RANGE FOR MAIN TERMINAL BLOCK (TBT):
27-30 IN. LBS. (31.1-34.5 kg cm)

CONNECT ONLY TO CIRCUITS PROTECTED BY A CLASS A GFCI.

A DISCONNECTING MEANS MUST BE INSTALLED WITHIN SIGHT FROM THE EQUIPMENT AND AT LEAST 5 FEET (1.52 M) FROM THE INSIDE WALLS OF THE POOL, SPA, OR HOT TUB.

TOTAL OUTPUT AMP DRAW NOT TO EXCEED MAX INPUT RATING OF SPA
USE EARTH GROUND CONNECTIONS AS INDICATED INSIDE THE SYSTEM ENCLOSURE

BALBOA
water group

BP2000G1 – PN 56377

10-23-12

PART B

Wiring Diagram - BP2000G1, Part Number 56377-01



BP2000G1 - PN 56377-01
01-29-13

J43 TO J13 (BLOWER ON J14)
IN SETUPS 3, 5, 9, 11, 12, 17, 18

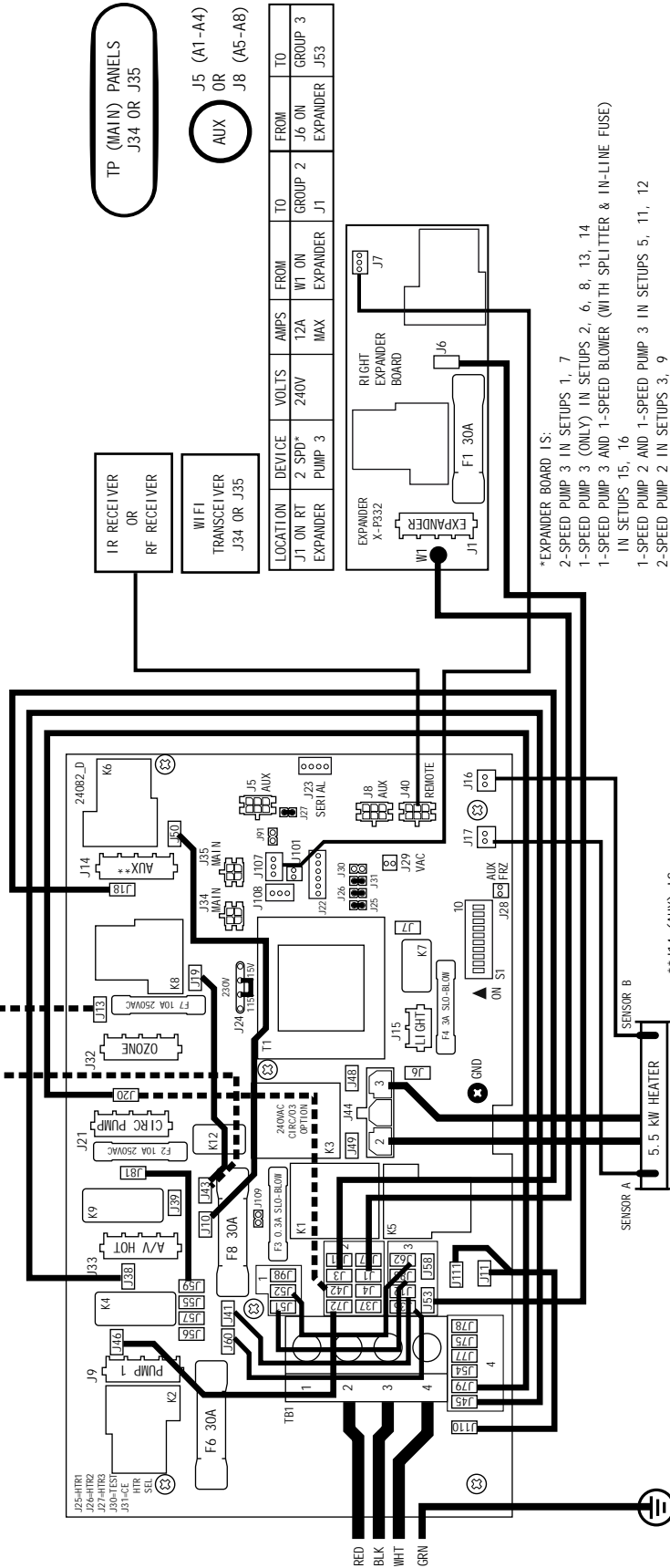

- *EXPANDER BOARD IS:
- 2-SPEED PUMP 3 IN SETUPS 1, 7
 - 1-SPEED PUMP 3 (ONLY) IN SETUPS 2, 6, 8, 13, 14
 - 1-SPEED PUMP 3 AND 1-SPEED BLOWER (WITH SPLITTER & IN-LINE FUSE) IN SETUPS 15, 16
 - 1-SPEED PUMP 2 AND 1-SPEED PUMP 3 IN SETUPS 5, 11, 12
 - 2-SPEED PUMP 2 IN SETUPS 3, 9
 - 1-SPEED PUMP 2 IN SETUPS 17, 18

- **J14 (AUX) IS:
- 2-SPEED PUMP 2 IN SETUPS 1-4, 7-10, 15, 16
 - 1-SPEED PUMP 2 IN SETUPS 5, 6, 11-14
 - 1-SPEED BLOWER IN SETUPS 3, 5, 9, 11, 12, 17, 18

PART A

Wiring Diagram - BP2000G1, Part Number 56377-01 (cont.)

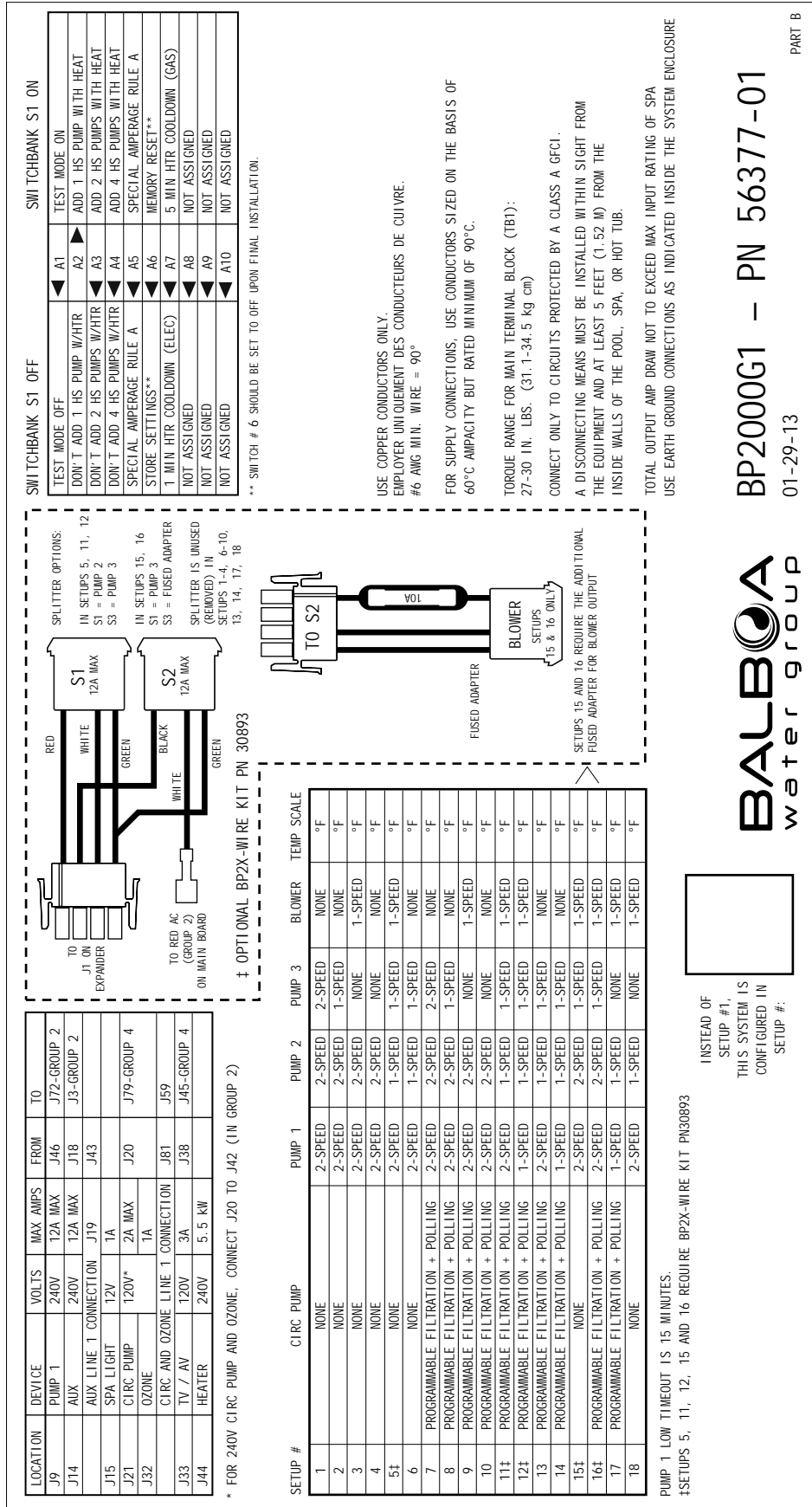

SWITCHBANK S1 OFF SWITCHBANK S1 ON

TEST MODE OFF	A1	TEST MODE ON
DOWN T ADD 1 HS PUMP W/HTR	A2	ADD 1 HS PUMP WITH HEAT
DOWN T ADD 2 HS PUMPS W/HTR	A3	ADD 2 HS PUMPS WITH HEAT
DOWN T ADD 4 HS PUMPS W/HTR	A4	ADD 4 HS PUMPS WITH HEAT
SPECIAL AMPERAGE RULE A	A5	SPECIAL AMPERAGE RULE A
STORE SETTINGS**	A6	MEMORY RESET**
1 MIN HTR COOLDOWN (ELEC)	A7	5 MIN HTR COOLDOWN (GAS)
NOT ASSIGNED	A8	NOT ASSIGNED
NOT ASSIGNED	A9	NOT ASSIGNED
NOT ASSIGNED	A10	NOT ASSIGNED

** SWITCH # 6 SHOULD BE SET TO OFF UPON FINAL INSTALLATION.

USE COPPER CONDUCTORS ONLY.
EMPLOYER UNIFORMEMENT DES CONDUCTEURS DE CUIVRE.

FOR SUPPLY CONNECTIONS, USE CONDUCTORS SIZED ON THE BASIS OF 60°C AMPACITY BUT RATED MINIMUM OF 90°C.

TORQUE RANGE FOR MAIN TERMINAL BLOCK (TB1):
27-30 IN. LBS. (31.1-34.5 kg cm)

CONNECT ONLY TO CIRCUITS PROTECTED BY A CLASS A GFCI.

A DISCONNECTING MEANS MUST BE INSTALLED WITHIN SIGHT FROM THE EQUIPMENT AND AT LEAST 5 FEET (1.52 M) FROM THE INSIDE WALLS OF THE POOL, SPA, OR HOT TUB.

TOTAL OUTPUT AMP DRAW NOT TO EXCEED MAX INPUT RATING OF SPA
USE EARTH GROUND CONNECTIONS AS INDICATED INSIDE THE SYSTEM ENCLOSURE

29

Wiring Diagram - BP20MSSH, Part Number: 56373 (MicroSilk, cont.)

LOCATION	DEVICE	VOLTS	MAX AMPS	FROM	TO
J9	2-SP PUMP 1	240V	12A MAX	J46	J72-GROUP 2
J14	2-SP PUMP 2	240V	12A MAX	J18	J3-GROUP 2
	PUMP 2 LINE 1 CONNECTION			J19	J10
J15	SPA LIGHT	12V	1A		
J21	CIRC PUMP	120V*	2A MAX	J20	J79-GROUP 4
J32	OZONE		1A		
	CIRC AND OZONE LINE 1 CONNECTION			J81	J59
J33	TV / AV	120V	3A	J38	J78-GROUP 4
J44	HEATER	240V	5.5 KW		

PUMP 2 IS 2-SPEED IN SETUPS 1 & 4
 PUMP 2 IS 1-SPEED IN SETUPS 2 & 5
 PUMP 2 IS NOT USED IN SETUPS 3 & 6

* FOR 240V CIRC PUMP AND OZONE, CONNECT J20 TO J42 (IN GROUP 2)

TEST MODE OFF	SWITCHBANK S1 OFF	SWITCHBANK S1 ON
DOWN T ADD 1 HS PUMP W/HTR	▲ A1	TEST MODE ON
DOWN T ADD 2 HS PUMPS W/HTR	▲ A2	ADD 1 HS PUMP WITH HEAT
DOWN T ADD 4 HS PUMPS W/HTR	▲ A3	ADD 2 HS PUMPS WITH HEAT
DOWN T ADD 4 HS PUMPS WITH HEAT	▲ A4	ADD 4 HS PUMPS WITH HEAT
SPECIAL AMPERAGE RULE A	▲ A5	SPECIAL AMPERAGE RULE B
STORE SETTINGS*	▲ A6	MEMORY RESET*
NOT ASSIGNED	▲ A7	NOT ASSIGNED
NOT ASSIGNED	▲ A8	NOT ASSIGNED
NOT ASSIGNED	▲ A9	NOT ASSIGNED
NOT ASSIGNED	▲ A10	NOT ASSIGNED

*SWITCH # 6 SHOULD BE SET TO OFF UPON FINAL INSTALLATION.

SETUP #	CIRC PUMP	PUMP 1	PUMP 2	MICROSILK®	TEMP SCALE
1	PROGRAMMABLE FILTRATION + POLLING	2-SPEED	2-SPEED	1-SPEED	°F
2	PROGRAMMABLE FILTRATION + POLLING	2-SPEED	1-SPEED	1-SPEED	°F
3	PROGRAMMABLE FILTRATION + POLLING	2-SPEED	NONE	1-SPEED	°F
4	NONE	2-SPEED	2-SPEED	1-SPEED	°F
5	NONE	2-SPEED	1-SPEED	1-SPEED	°F
6	NONE	2-SPEED	NONE	1-SPEED	°F

PUMP 1 LOW TIMEOUT IS 15 MINUTES.

INSTEAD OF
 SETUP #1,
 THIS SYSTEM IS
 CONFIGURED IN
 SETUP #:



MICROSILK IS A REGISTERED TRADEMARK OF JASON INTERNATIONAL

USE COPPER CONDUCTORS ONLY.
 EMPLOYER UNIFORMEMENT DES CONDUCTEURS DE CUIVRE.
 #6 AVG MIN. WIRE = 90"

FOR SUPPLY CONNECTIONS, USE CONDUCTORS SIZED ON THE BASIS OF
 60°C AMPACITY BUT RATED MINIMUM OF 90°C.

TORQUE RANGE FOR MAIN TERMINAL BLOCK (TB1):
 27-30 IN. LBS. (31.1-34.5 Kg cm)

CONNECT ONLY TO CIRCUITS PROTECTED BY A CLASS A GFCI.
 A DISCONNECTING MEANS MUST BE INSTALLED WITHIN SIGHT FROM
 THE EQUIPMENT AND AT LEAST 5 FEET (1.52 M) FROM THE
 INSIDE WALLS OF THE POOL, SPA, OR HOT TUB.

TOTAL OUTPUT AMP DRAW NOT TO EXCEED MAX INPUT RATING OF SPA
 USE EARTH GROUND CONNECTIONS AS INDICATED INSIDE THE SYSTEM ENCLOSURE

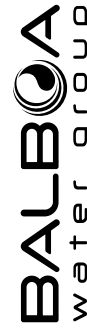

BP20MSSH - PN 56373

01-03-13

PART B

Troubleshooting Using Resistance - Ohm's Law

OHM'S LAW

The direct current flowing in a conductor is directly proportional to the potential difference between its ends. It is usually formulated as $V=IR$, where V is the potential difference, or voltage, I is the current, and R is the resistance of the conductor.

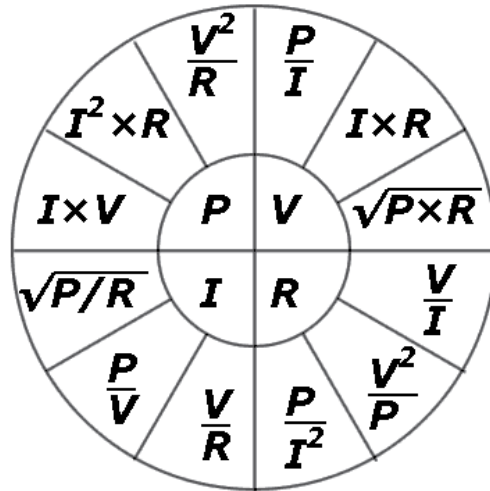

Quantity	Symbol	Unit of Measurement	Unit Abbreviation
Current	I	Ampere ("Amp")	A
Voltage	E or V	Volt	V
Resistance	R	Ohm	Ω

CONTINUITY



Testing a Fuse: Continuity

NOTE: THERE ARE NO SERVICEABLE PARTS ON THE PCB.

THE PREFERRED WAY TO CHECK FOR FUSE CONTINUITY IS WITH THE FUSES REMOVED FROM THE CIRCUIT.



TESTING A FUSE: CHECK CONTINUITY WITH THE FUSE REMOVED



A FUSE WITH THE METER READING "GOOD"



A FUSE WITH THE METER READING "BAD"

FUSES USED ON BP SPA SYSTEMS	
Fuse	BWG Part Number
30A	30136
10A	30122
3A Slo-Blo	20600
0.3A Slo-Blo	21581
0.15A Slo-Blo	26281
0.125A Slo-Blo	26397



Troubleshooting Heater Resistance



TEST IS WITH POWER OFF

TROUBLESHOOTING HEATER RESISTANCE

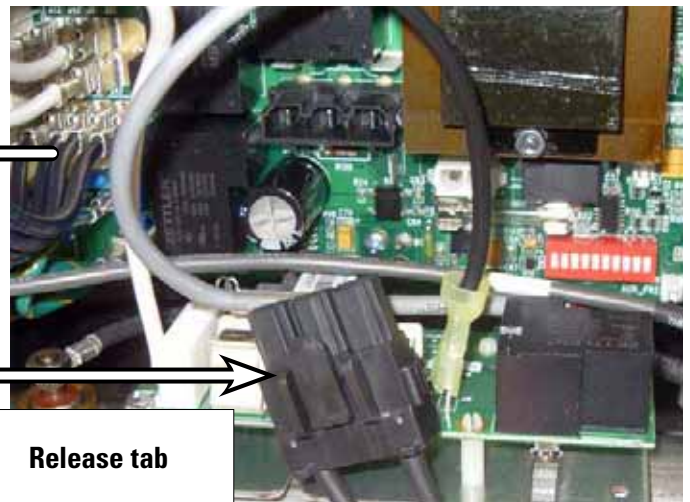

**Locate the heater connector.
Disconnect the connector by depressing the tab.**

Pull the connector straight out.



Place the meter probes on the heater terminals.

ACCEPTABLE HEATER OHM (Ω) RANGES

Heater Type	Ohms (Ω)
5.5 kW @ 240 V	9.42 Ω -11.52 Ω
4 kW @ 240 V	12.96 Ω -15.84 Ω
1 kW @ 120 V	12.96 Ω - 15.84 Ω

**Note: 1 k Ω = 1000 Ω :
k Ω may vary +/- 10% depending on the accuracy of
the meter used.

Troubleshooting Heater Posts Resistance to Heater Housing



TEST IS WITH POWER OFF

TROUBLESHOOTING HEATER POSTS RESISTANCE TO HEATER HOUSING

VERIFY THAT THERE IS NO HEATER "LEAKAGE"

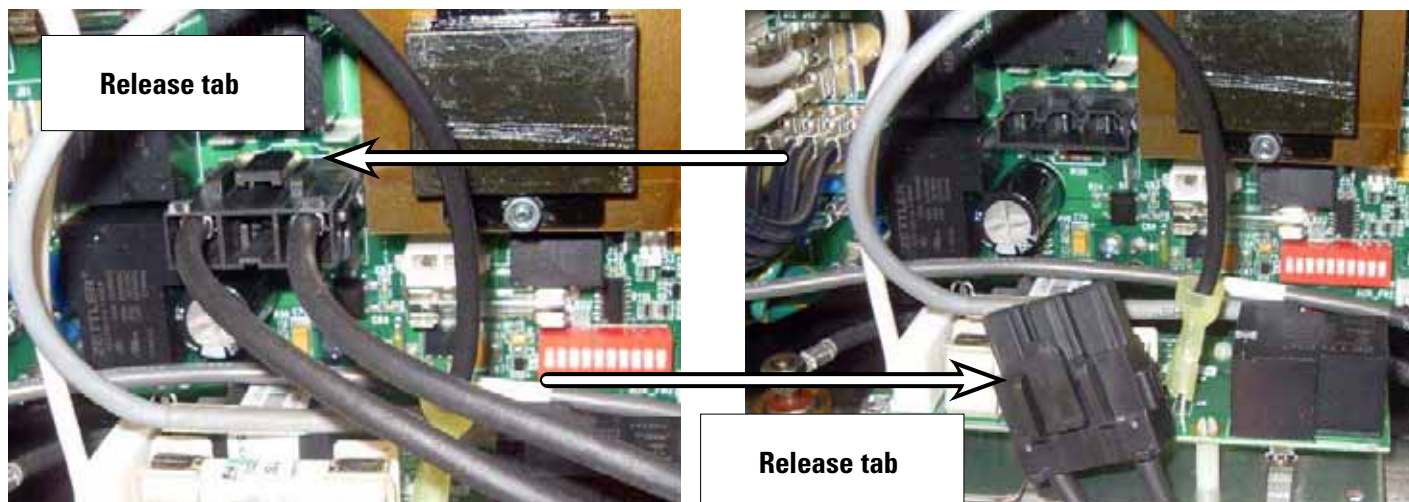

**Locate the heater connector.
Disconnect the connector by depressing the tab.**

Pull the connector straight out.



Measure resistance from a heater post to the heater housing

Verify there is NO continuity from the heater post to the heater housing or heater current collector connection. The meter reading shown is OL, indicating infinite resistance.



Verify there is NO continuity from the heater post to the ground/earth. On the resistance scale, the a digital meter should read OL (indicating infinite resistance).

Troubleshooting with Voltage



IMPORTANT!

**BEFORE TESTING A SPA CONTROL SYSTEM FOR VOLTAGE OR
AMPERAGE, BE SURE OF THE FOLLOWING DANGERS:
HIGH AND LOW VOLTAGE CAN KILL.**

QUALIFIED TECHNICIANS SHOULD BE PERFORMING THESE TESTS



WHEN TESTING VOLTAGE

OR



WHEN TESTING AMPERAGE

OBSERVE SAFETY AT ALL TIMES

Verifying Incoming Voltage at the Terminal Block - BP500, BP2000G1



CAUTION - TEST IS WITH POWER ON

**VERIFYING INCOMING VOLTAGE AT THE TERMINAL BLOCK (240V SYSTEM)
BP2000 SHOWN (BP500 SYSTEM IS SIMILAR)**

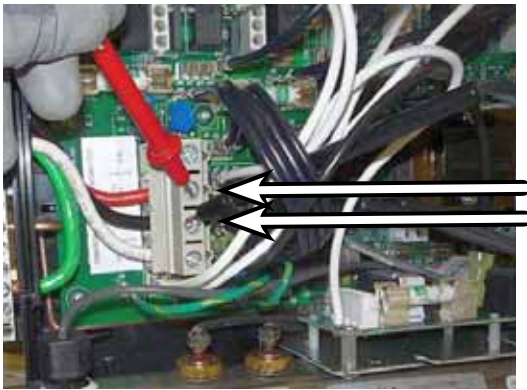

Red to Black Wires = 240V

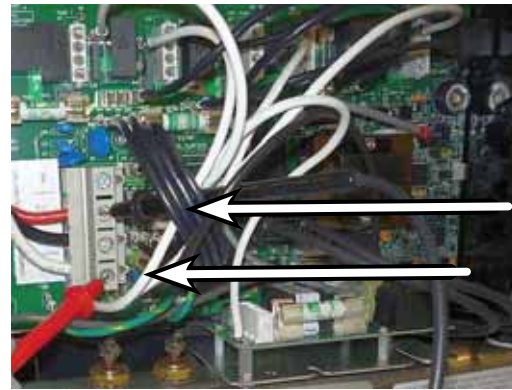

White to Red Wires = 120V

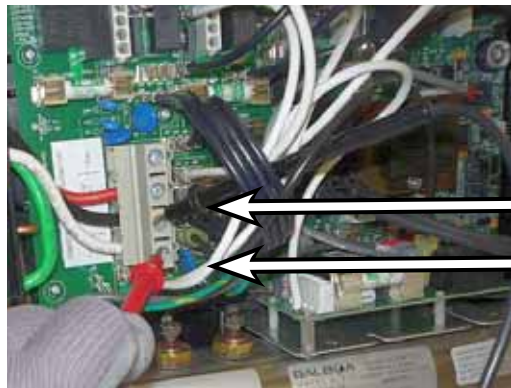

White to Black Wires = 120V

Testing Pump Fuses for Damage with Voltage On - BP2000G1



CAUTION - TEST IS WITH POWER ON

THERE ARE THREE 30A PUMP FUSES IN THE BP2000G1 SPA CONTROL SYSTEM.

F6 AND F8 ARE ON THE MAIN BOARD. F1 IS LOCATED ON THE EXPANDER BOARD.

**TEST THE VOLTAGE FROM THE
LEFT SIDE OF THE FUSE**

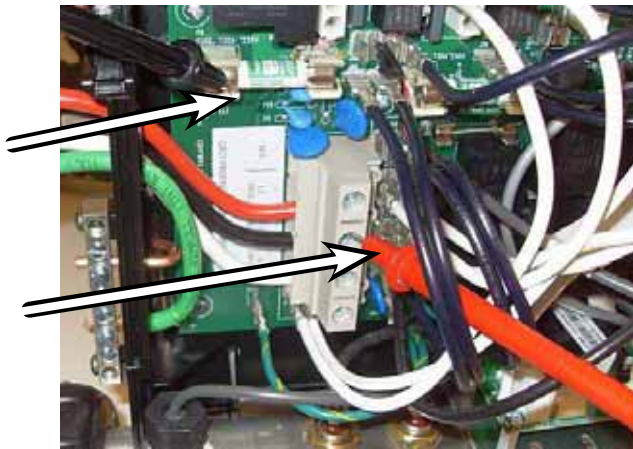

**F6 TO TB1
RED**

**TEST THE VOLTAGE FROM THE
RIGHT SIDE OF THE FUSE**

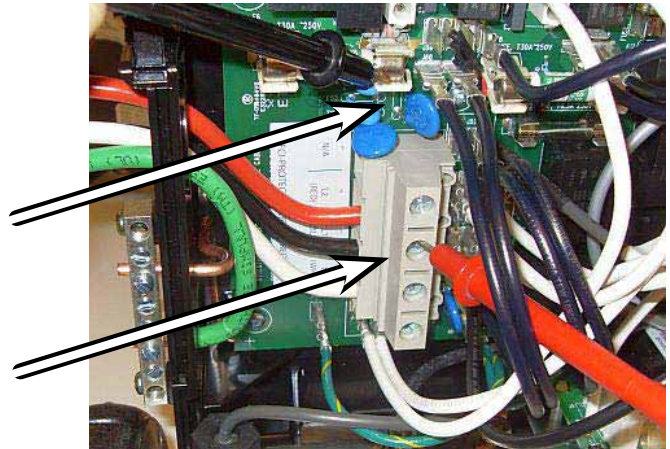

**240V on each side
indicates a good fuse**

**240V on one side and
0V on the other side
indicates a bad fuse**

**Then continue
measuring the other
two fuses: F8, F1**

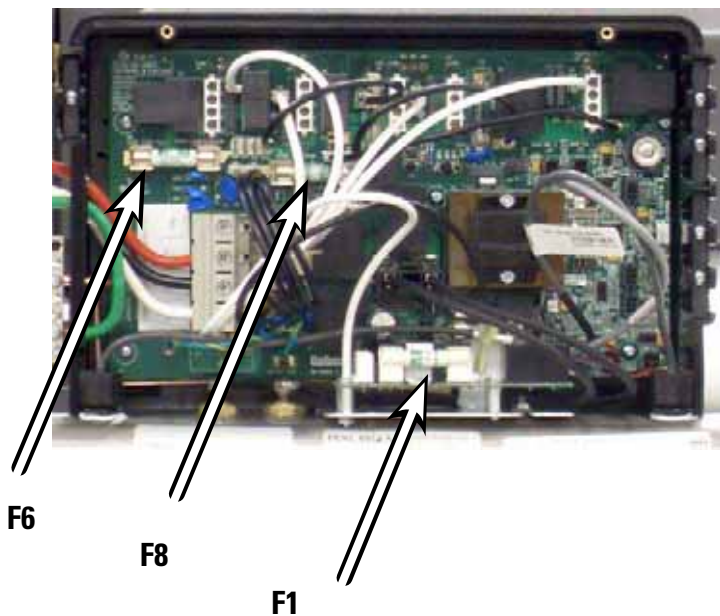

Testing Heater Voltage - All BP Systems

⚠ CAUTION - TEST IS WITH POWER ON.

Testing at the heater terminal verifies that there is not a broken line to the heater. It may also indicate problems that may not be apparent visually, such as corrosion or a damaged heater terminal post.

However, before you do test, read on...



⚠ AVOID TOUCHING THE HEATER ASSEMBLY WHILE PERFORMING THIS TEST.

THE HEATER IS ATTACHED TO GROUND.

Many people use probes to test live heater voltages from TB1 to a heater post, or across both posts.

DON'T.

There is danger in measuring voltages across heater posts. Some of the common problems in testing spa systems are that:

1. The area is often tight and confined.
2. The area is often not well lit.
3. Spa control systems are usually placed at near ground level, which makes measuring with meter probes awkward or difficult. The probes may have a tendency to slip or not touch the designated point of test. If a probe slips and simultaneously contacts a hot (240V) post and ground, severe arcing will occur. **DEATH OR SEVERE INJURY CAN OCCUR.**

(continued on next page)

WRONG!
**DO NOT MEASURE
ACROSS HEATER TERMINALS**



A Safer Way to Test Heater Voltages

Equipment needed:

- Insulated clamps for your voltmeter probes

Suggested attire:

- Safety glasses
- Rubber gloves (when measuring live electrical wires)

1. Turn the power OFF to the spa control system.
2. Set voltmeter for AC high voltage reading. Set clamps onto terminals securely. Be sure that both insulated boots *fully cover the clamps*. Be sure that both clamps are not touching each other and that they are not making contact with anything below the insulating material on the terminal. (See photo below.)
3. Turn on power to the spa. Do not disturb the voltmeter or clamps until the power is turned off.
4. With the system operating and the panel display set for the need for heat, verify the voltage at the heater posts. On a 240V system, the reading will be near 240V. (Allow for +/- 10% variance.)
5. When finished with testing, turn the power off before removing the clamps from the terminal posts.



Be sure that both clamps are not making contact with anything below the insulating material on the terminal (arrows).

Note: Black boot removed below to show detail.

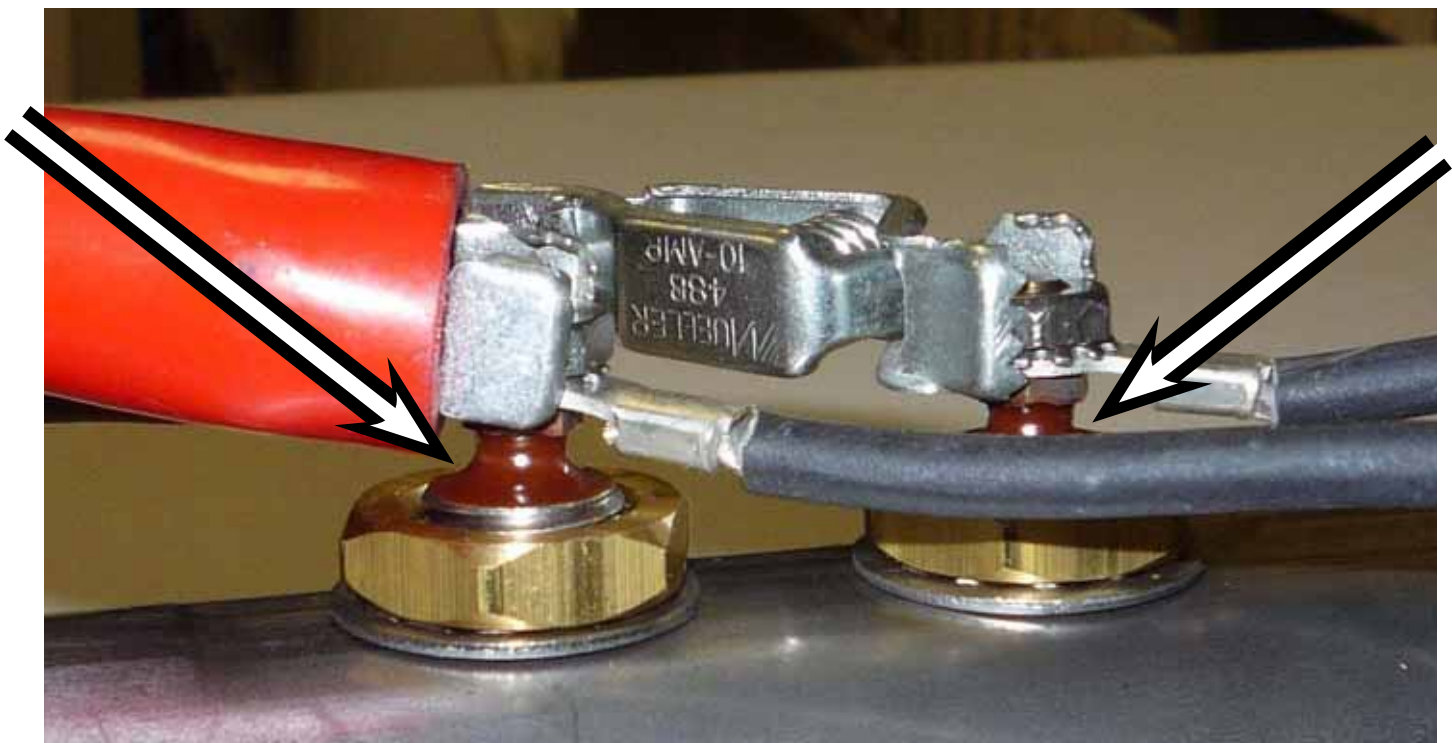

Testing Pump Fuses for Damage with Voltage On - BP500

Due to the design of the BP500, the upper Logic board must be moved out of the way to test most of the power board fuses.

To gain access to the power board:

1. Power down the system.
2. Remove the sensor wires from the logic board. Be sure to depress the release tab on the sensor connector. Do not pull on the wire.
3. Remove the four corner retaining screws.
4. Place the Logic board out of the way of any metal or points of system voltage or grounding areas once the system is powered up.

Note: One consideration to isolate the logic board from the metal chassis is to place a non-conductive material separating the components (below).

Also, if you must move the components around for testing, add or remove sensors or wires, take a few moments to power down the system.

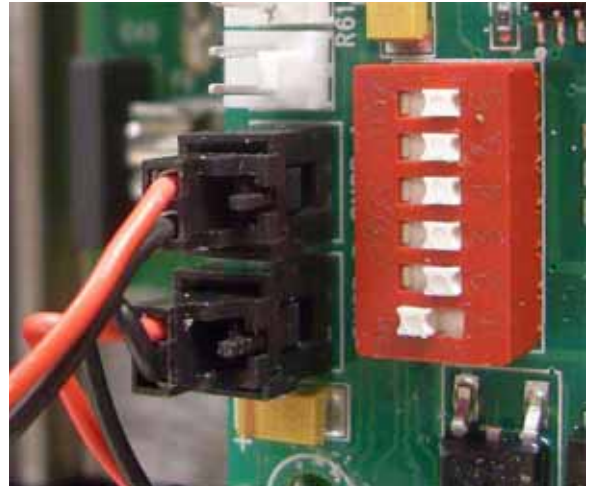

Sensor Location BP500, on Logic Board



**Depress sensor tab
when removing**



For safety, an antistatic bag, a piece of cardboard (as shown here), or any other insulator should be used to separate the chassis ground from the logic board.

The Logic board must not be in contact with any hot spots, chassis ground, or floor of the spa area when the system is powered up for testing. Be especially careful if the surrounding floor area is wet.

Testing Heater Amperage



CAUTION - TEST IS WITH POWER ON

PLACE CLAMP AROUND ONE HEATER WIRE, AND THEN THE OTHER WIRE.



AMPERAGE HEATER TEST BP500



AMPERAGE HEATER TEST BP2000G1

ACCEPTABLE HEATER AMPERAGE DRAW RANGES

Heater Type	120V Amp Draw	240V Amp Draw
5.5 kW @ 240 V	10.42 A - 12.74 A	20.83 A - 25.48 A
4 kW @ 240 V	7.58 A - 9.26 A	15.15 A - 18.52 A
1 kW @ 120 V	7.58 A - 9.26 A	-

Testing Low Speed and High Speed at the AMP Pump Connector

TESTING LOW SPEED AND HIGH SPEED AT THE AMP CONNECTOR



CAUTION - TEST IS WITH POWER ON

Board Connector Key

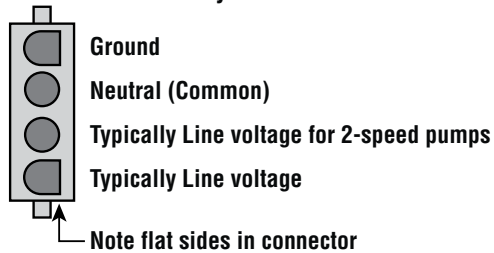

**WITH THE PUMP LOW SPEED ON,
TAKE A VOLTAGE READING AT THE
AMP RECEPTACLE ON THE PCB**

**THIS WOULD TYPICALLY SHOW LOW
SPEED VOLTAGE FOR PUMP ONE. (240V)**

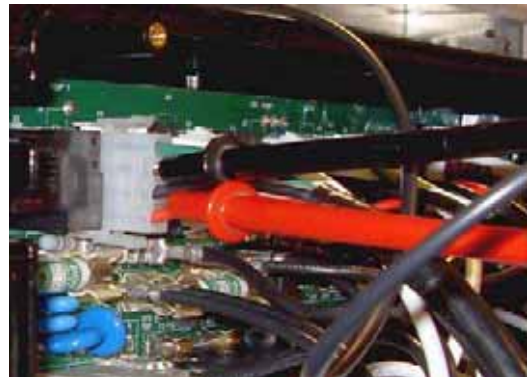

**WITH THE PUMP HIGH SPEED ON,
TAKE A VOLTAGE READING AT THE
AMP RECEPTACLE ON THE PCB**

**THIS WOULD TYPICALLY SHOW HIGH
SPEED VOLTAGE FOR PUMP ONE. (240V)**



**Note: These are typical settings only.
Voltages may be different depending
on the configuration that the system is
set to. See the system's Tech Sheet for
complete information.**



PUMP 1 AMP CORD

Component Failure and Replacement Testing - Software Setups and Test Mode

All BP systems have the capability for Test Mode. Test Mode is used when changing setup configurations through the panel, which also means that wiring changes may be necessary. (See the specific spa control system Tech Sheet for more details.)

Note: Although Test Mode allows access to certain utility features, most Utilities are available without entering Test Mode. A/B Sensor Temperatures and Fault Log information are presented here since they appear on the Test menu screen (see below).

**DANGER! HIGH VOLTAGE WILL BE ACCESSIBLE!
SERVICE TECHNICIAN ONLY!**

TEST MENU ACCESS (S1, SWITCH 1 ON)

SOFTWARE SETUPS

Under the TEST Menu, the Setup screen will allow changing the Setup from 1 to any number established by the manufacturer. Changing the Setup may require wiring changes as well.

1. While the system is running, move DIP Switch 1 (on S1 on the Main circuit board) to ON.
2. The system will enter Test Mode. On the home screen (below) will appear the word TEST.
3. Change the setup to the desired setup configuration number (depending on DIP switch or wires changes, if any).
[\(Test Mode On\) Test > Setup](#)
4. Moving DIP Switch 1 to OFF will exit Test Mode

**The Control System is in Test Mode if 102°F appears.
(In this case °F or °C is replaced by °T.)**

OTHER TEST MODE FEATURES:

A/B TEMPS (A/B SENSOR TEMPERATURES)

When this is set to On, the temperature display will alternate to display temperature from Sensor A and Sensor B in the heater.

FALT LOG (FAULT LOG)

The Fault Log is a record of the last 24 faults that can be reviewed by a service tech.

DEMO (DEMO MODE)

Demo Mode is not always enabled, so it may not appear. This is designed to operate several devices in a sequence in order to demonstrate the various features of a particular hot tub.

TIME OUTS

Used only by the manufacturer for specific tests.

TEMP LIMIT

Used only by the manufacturer for specific tests.

VIEWING CONFIGURATION SETTINGS

There are times when a technician may want to view the configuration settings (or, config. setup) before working on a system. View the configurations in the following way:

TP900/TP800 panels: System Information > Current Setup

TP600/TP400 panels: UTIL > INFO > SETP (Standard Menus)

TP600/TP400 panels with Simplified Menu can only access the configuration setup when in test mode.

Note: In the event that a panel stops operating, a good working panel plugged into the system will reveal the config. settings as they are held in memory.

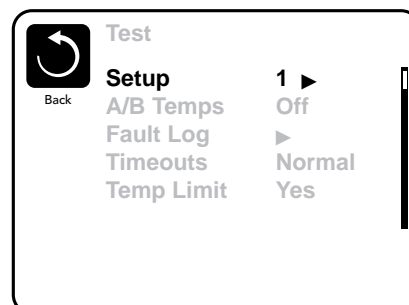
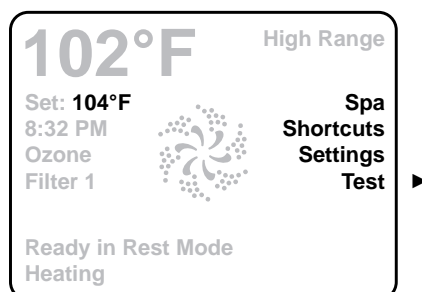
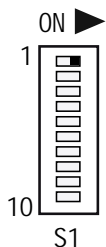

Setup Changes with DIP Switch 1 ON - BP500

Note: For complete variations of equipment configurations and setups, the latest Tech Sheet should be obtained on the system you're working on. The information for setup changes is included here in the event you have wiring diagrams available, and to facilitate a better understanding of how setup changes are made.

READ AND UNDERSTAND THESE INSTRUCTIONS BEFORE BEGINNING THIS PROCESS.

Know the Setup Number you want before you power up the spa and wait to power up the spa until you're ready to change the Setup Number.

The system must be in Test Mode, so move Switch 1 to the ON position. The Test Menu will then be available.

Power up the spa, and press any button once to Link the panel. (Note: Switch 1 can be moved to the ON position immediately after power-up, if preferred - **Danger! High Voltage will be present!**)

You will have 1 minute to complete the setup change after you manually exit Priming Mode. (Once familiar with the process, the Setup change should take less than 15 seconds.)

→ As soon as Switch #1 is placed in the ON position, the temperature will show "T" after it instead of F or C, indicating the System is in Test Mode

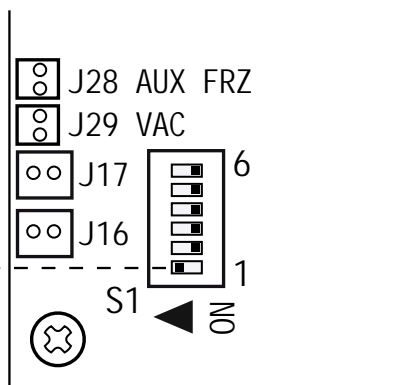

When the panel displays RUN PMPS PURG AIR, press any Temperature button ONCE to exit Priming Mode. You should see "---T" where the T indicates the system is in Test Mode.

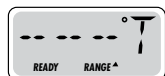

Continued on Next Page.

Setup Changes with DIP Switch 1 ON - BP500 (cont.)

Again, You will have 1 minute to complete the setup change after you manually exit Priming Mode.

Immediately after exiting Priming Mode, press this sequence of buttons: Warm*, Light, Warm, Warm, Warm, Warm. Continue to press Warm until the display shows the Setup Number (S-01, S-02, etc.) you want to switch to. When the correct setup number is showing, press Light once, and the system will reset, using the newly-selected Setup from that point on.

Move DIP Switch 1 to the OFF position to take the spa out of Test Mode. °F or °C will replace °T.

Using a permanent marker, write the Setup number on the Setup label mounted inside the system lid (right). This is very important to any service person in the future who may need to replace a circuit board or system and needs to change the Setup on a replacement part while in the field.

NOTE: Changing the Setup may require wiring changes as well - refer to the wiring diagram or wiring diagram addendum.

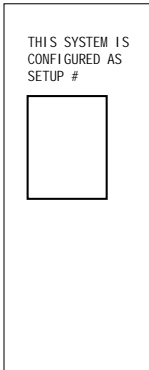

Key

- Indicates Flashing or Changing Segment
- Indicates Alternating or Progressive Message - every 1/2 second
- ⌋ A temperature button, used for "Action"
- ☀ Light or dedicated "Choose" button, depending on control panel configuration
- Waiting time - varies depending on function

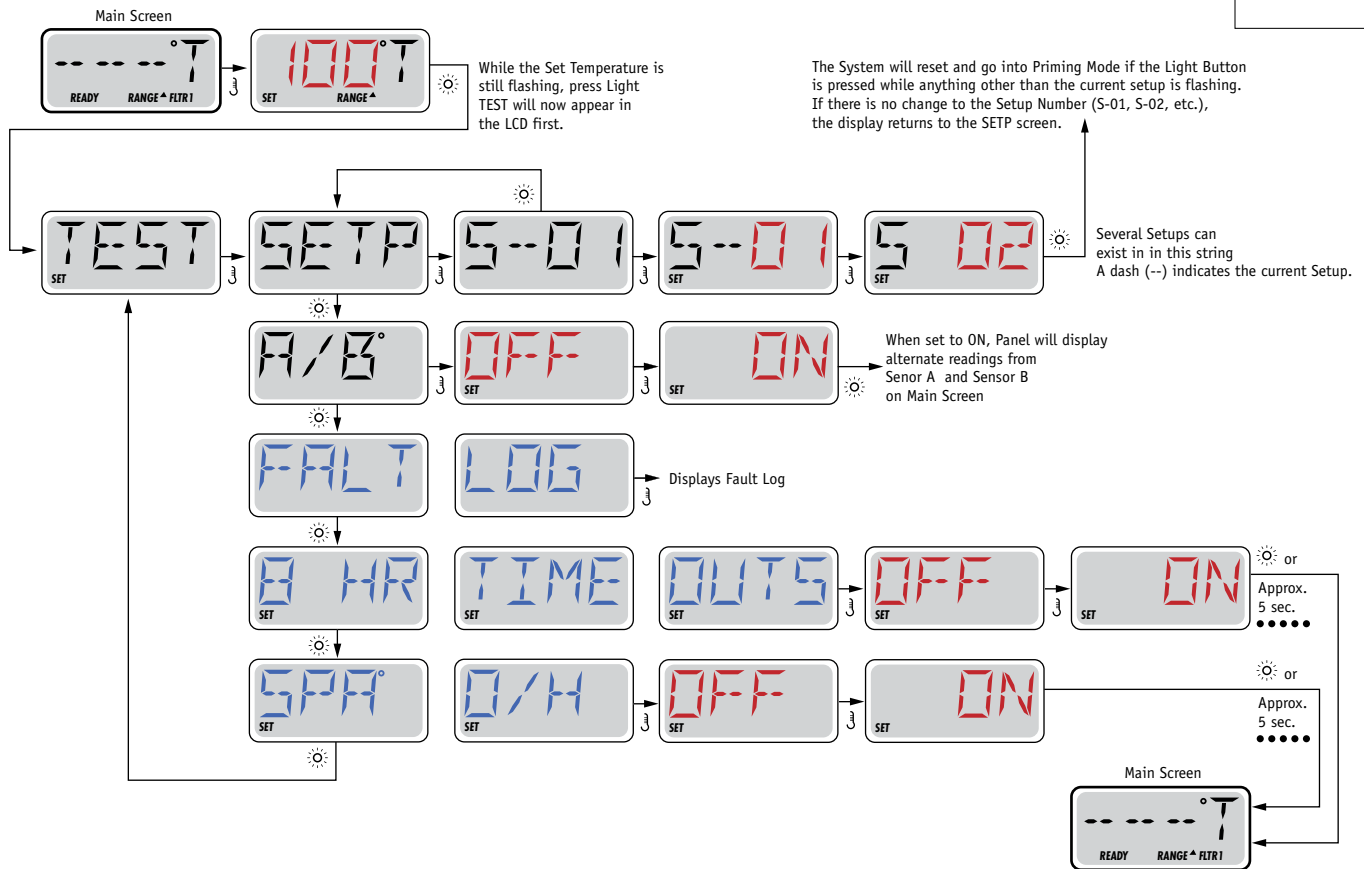

*If the Control Panel does not have a Warm (Up) button, but rather a single Temp button, use the Temp button in place of the Warm button in the instruction above. (The flow chart assumes a single Temperature Button.)

Setup Changes with DIP Switch 1 ON - BP2500

Note: For complete variations of equipment configurations and setups, the latest Tech Sheet should be obtained on the system you're working on. The information for setup changes is included here in the event you have wiring diagrams available, and to facilitate a better understanding of how setup changes are made.

TEST MENU ACCESS (S1, SWITCH 1 ON) SERVICE TECHNICIAN ONLY.

DANGER! HIGH VOLTAGE WILL BE ACCESSIBLE! SERVICE TECHNICIAN ONLY!

While the system is running, move DIP Switch 1 (on S1 on the Main circuit board) to ON.
The system will enter Test Mode.
Moving DIP Switch 1 to OFF will exit Test Mode.

SOFTWARE SETUPS (BP2500)

Under the TEST Menu, the Setup screen will allow changing the Setup from 1 to any number established by the manufacturer. Changing the Setup may require wiring changes as well.

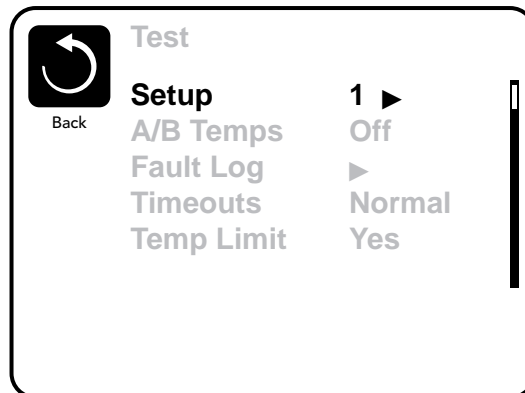
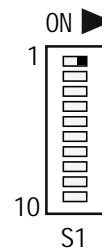
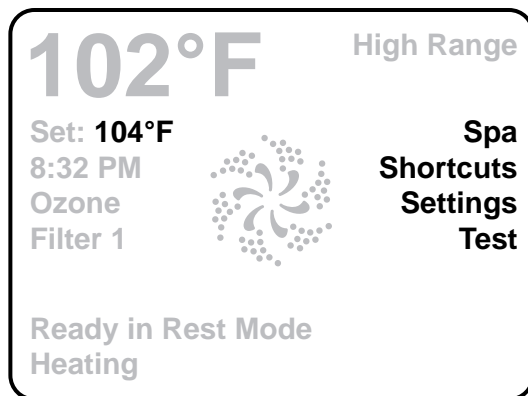

Testing the Sensor Set

1. Begin the diagnosis with the power off. Check sensor wires for cracks or damage that may indicate the presence of a rodent.
2. Inspect the connections of both sensors on the circuit board. The plugs must be clean.
3. If the sensors are not totally failing but are showing excessive ($2^{\circ}\text{F}/1.0^{\circ}\text{C}$ or more) difference between the two sensors when not heating (a possible cause of Sn/SnS/SENSOR SYNC, HL/HFL/HTR FLOW LOW, and LF/LOW/FLOW/messages), do the following:
 - Note which sensor is reading consistently higher (A vs B or T vs H).
4. Unplug the two sensors from the circuit board and exchange their positions (i.e., plug the one that was in the "Sen. A" jack into the "Sen. B" jack and vice versa).
Note: When removing a sensor wire from the board, depress the tab. **Do not pull on the wire.**
5. Press a panel button if any "stray" faults appeared during the process. (Stray faults are normal when sensors are unplugged then plugged back in while the system is running.)
6. Within a minute or so, see if the same or other sensor is now reading consistently higher:
 - If the same sensor (A vs B or T vs H) is reading higher after the sensor interchange, the problem is on the circuit board. Replace the circuit board.
 - If the opposite sensor is now reading higher, the problem is with the sensor(s). Replace the sensor set.
** If you wait more than 2 minutes after plugging the sensors back in, heating may start (even outside a filter in Economy or Sleep mode) due to a stray Cd/CLd/COLD WATER condition usually detected when sensors are being plugged in while the system is running.*



Depress tab
when removing

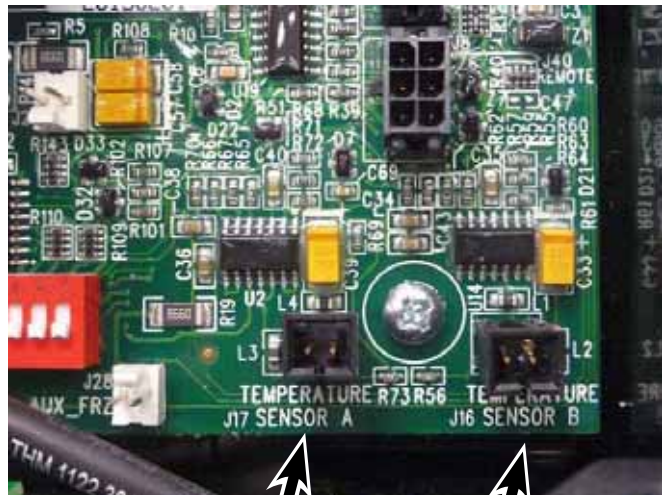

TEMPERATURE SENSORS LOCATION
(WIRES REMOVED)

Testing the Sensor Set (cont.)

7. If there is a message indicating an open or faulty sensor:
- Unplug the sensor set (but leave the original sensors in the heater) and plug in the test sensor set. Put both sensors into the same cup of warm water (ideally above the set temperature, so the spa won't try to heat during this test, as there is no heater protection during this test) and verify that they read the same temperature (within 1°F/0.5°C).
 - If the problem is solved, replace the sensor set. If the problem is not solved, do not replace the sensor set.
 - Plug in the original sensor set to verify that there is not a connection problem.
 - If the problem continues after following the above steps, then replace the circuit board.

M-7 Replacement Sensor

M-7 REPLACEMENT SENSOR

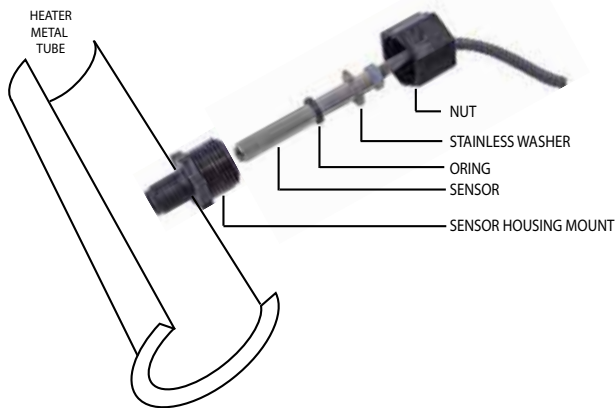

TESTING SENSOR PINS

ALWAYS TURN THE POWER OFF WHEN PLUGGING AND UNPLUGGING!

Sensor Pins: At times, a protective coating may on accident coat the sensor pins during manufacturing. Those pins may need to be scraped and the sensors plugged back in.

Tip: If one sensor (A or B) seems to be having problems, swap the cables of sensor A with sensor B.

If the problem stays with the same sensor (according to topside messages) it's a board problem; if the problem moves to the other sensor it's a sensor problem.

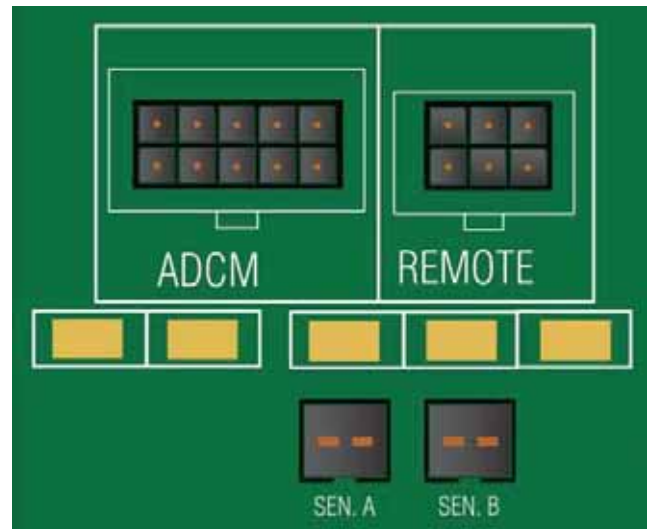

(Sample Board Shown)

Remove and Replace a System Circuit Board

IMPORTANT!

BE SURE TO TURN THE POWER OFF BEFORE REPLACING ANY COMPONENT, ESPECIALLY A CIRCUIT BOARD.

IMPORTANT!

DO NOT REMOVE AND REPLACE THE CIRCUIT BOARD UNLESS THE FAULT HAS POSITIVELY BEEN DETERMINED TO BE THE CIRCUIT BOARD.

REMOVING A SYSTEM CIRCUIT BOARD

- Shut OFF line power to the spa at the main circuit breaker panel. Do not attempt to service a spa without shutting off the power. Serious injury or damage may result. Consider placing a padlock on the main service disconnect box while working on the spa.
- Before you begin, consider labeling all wires that will be removed from the board. This may help speed up reinstallation. Other technicians prefer to take the board out with wires intact, place both defective and new board side by side on a bench, then swap wires, recheck the logic jumpers, and DIP switch for proper configuration. Whatever technique is used, a wiring diagram should always be used to ensure proper wire placement.
- Remove the sensor wire connectors at the board, and the J44 heater connector on the BP2000 Board (located to the left of the transformer). Be sure to use the release tab on the connectors; do not pull on the wires.
- Some BP spa control systems use an expander board. Removing the expander board first simplifies the process. To remove it, remove the screw, and then gently squeeze the locking flange on each standoff with needle nose pliers while lifting the board out. Some technicians, after removing the screw (and if the standoffs allow it), gently pry the board up where there's a plastic stand off. Do not use excessive force if the standoff will not yield. Do not pry up directly into the board as damage to the board may result.
- Remove the seven screws (if BP2000, see illustration).
- The board should now be free and can be removed from the system box.

Removing BP Expander Board, an Alternate Way

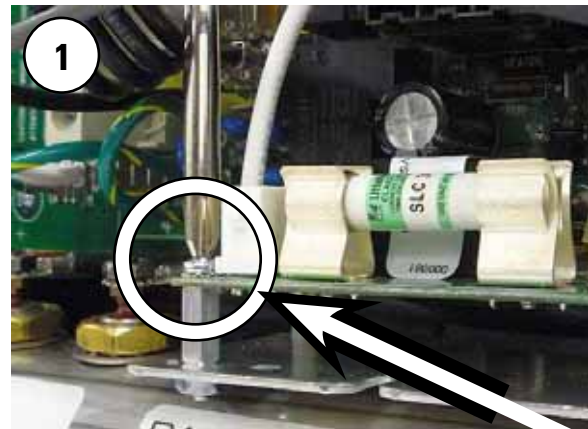

Remove and Replace a System Circuit Board (cont.)

INSTALLING A SYSTEM CIRCUIT BOARD

When reinstalling the board:

- Torque main board hold down screws to 8-10 in/lbs. Do not over tighten as damage to the board may result.
- Reconnect all wires and slip-on connectors.
- Restore power to the spa at the main breaker.
- Test to make sure all functions work correctly.

COMPATIBILITY ON DUAL BOARD CONTROL SYSTEMS

System BP600 has two boards: a power board and logic board. If one board is found to be defective and is replaced with a newer revision board, it will still be compatible with the other, older system board.

BP2100 board screw locations

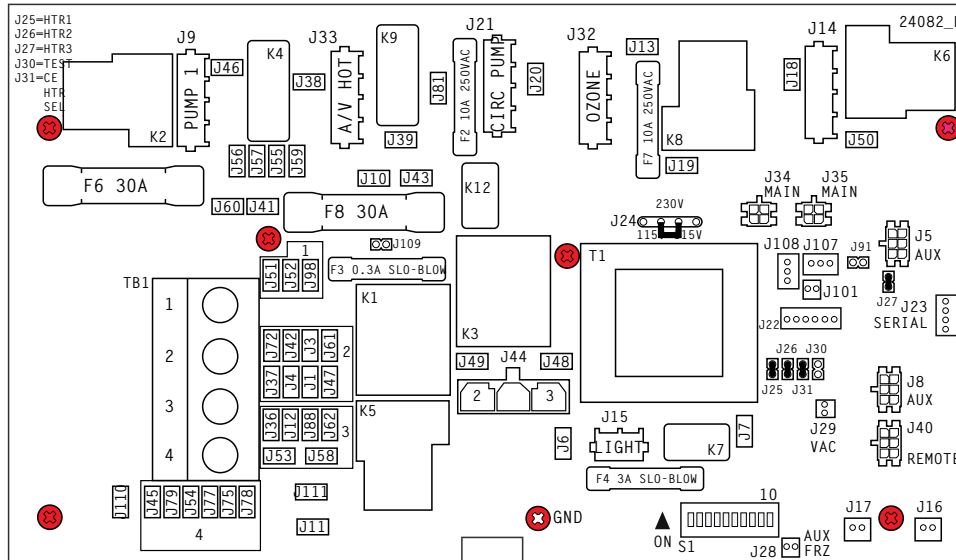

BP2100 board without wires



Removing the Heater Assembly from a BP Spa System

Note: Be careful when removing a heater assembly from a spa plumbing system. Water may splash out under pressure. See next page for more illustrations.

Water under pressure in the plumbing may splash out, and onto the system's electronic board. Do not remove the system door until the water has been drained from the heater assembly housed in the system.

1. Turn off the main power.
2. Close off the slice valves (or, ball valves) adjacent to the heater assembly.
3. Once the valves are closed, slowly crack the heater assembly end tubes until water flows out. If the connectors are on too tight, it may be necessary to loosen the Phillips screws that hold the connectors together. Once the water has been drained, continue.
4. Remove the system door cover.
5. **If you received the heater kit with wires** (BP2000/ BP2100 Series systems, see right):
Depress the tab on the heater connector to remove it.
6. **If you received a heater without the wire kit or if you need to replace the heater wires (see next page):**
 - a) Remove the nuts securing the heater wires to the heater assembly's terminal connectors. **Be sure to use a supporting end wrench on the lower nut.** (Upper nut is 3/8"; lower nut is 1/4".) If a lower end wrench is not used to hold the terminal in a fixed position when **removing or installing the upper nut**, excessive torque will transfer to the terminal connector and will probably damage it.
7. Replace the heater sensor wires as necessary.
8. Remove both 3/8" nuts that secure the element in place.
9. Remove the heater assembly.
10. Reverse the procedure to reinstall the heater assembly.

Note: Heater terminal nut installation is 30 - 35 in lbs. torque.

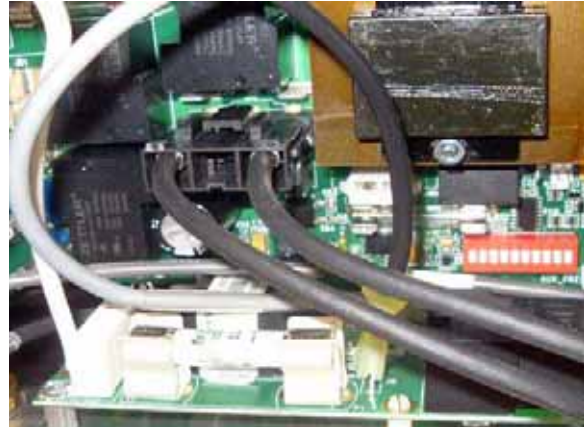

Heater Connector on BP2000/BP2100 Series

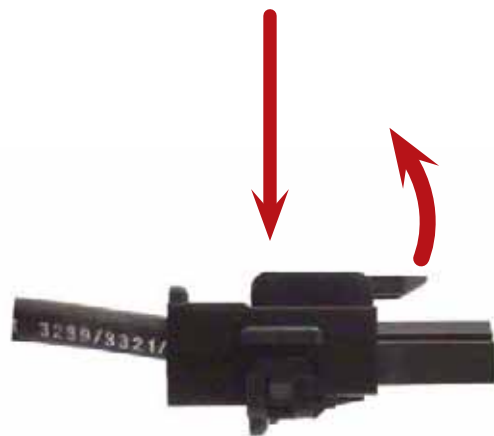

Side View: Depress Tab to Unlock Connector



Removing the Heater Assembly from a BP Spa System (cont.)

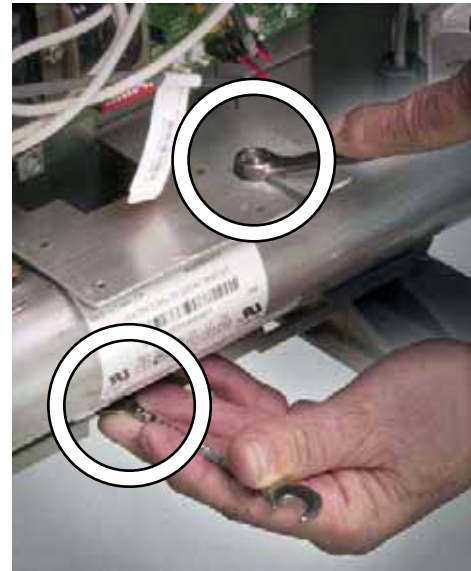
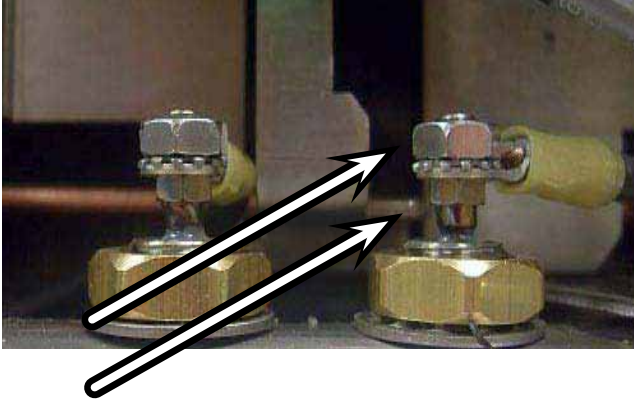

Remove both nuts that secure the element in place.

Locking nuts are in the same location on other BP models

Avoid damaging the post. Use an end wrench on the lower nut to reinforce the post when removing the upper nut.

Heater Wires on a BP500/BP600 Series system are connected to the lower Power Board.

The Logic Board must be removed to access and remove the heater wires, shown in red.

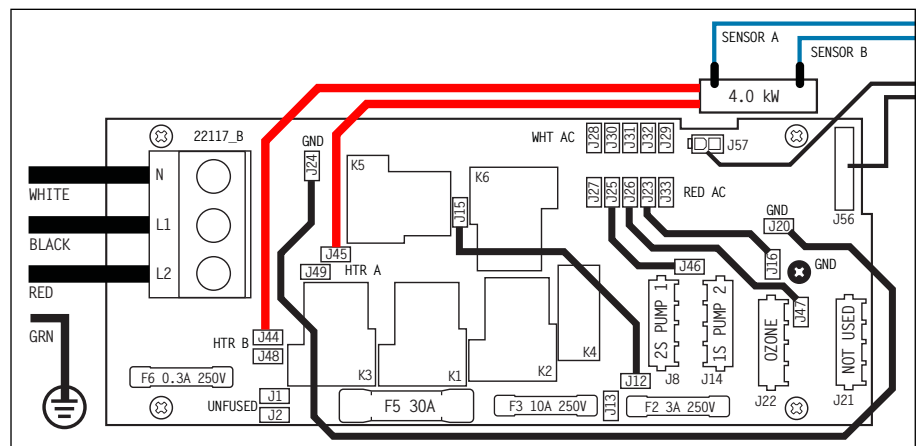

TP800, TP900 Panel Operations - The Main Screen - Navigation

SPA STATUS

Important information about spa operation can be seen quickly from the Main Screen. The most important features, including Set Temperature adjustment, can be accessed from this screen.

The actual water temperature can be seen in large text and the desired, or Set Temperature, can be selected and adjusted.

Time-of-day, Ozone operation and Filter Operation status is available, along with other messages and alerts

High Temperature Range vs. Low Temperature Range is indicated in the upper right corner

The Jets Icon in the center will spin on a TP900 if any pump is running and changes color when the heater is on. (The icon does not spin on a TP800, but still indicates pump and heater function)

A Lock icon is visible if the panel or settings are locked.

The Menu choices on the right can be selected and the screen will change to show more detailed controls or programming functions.

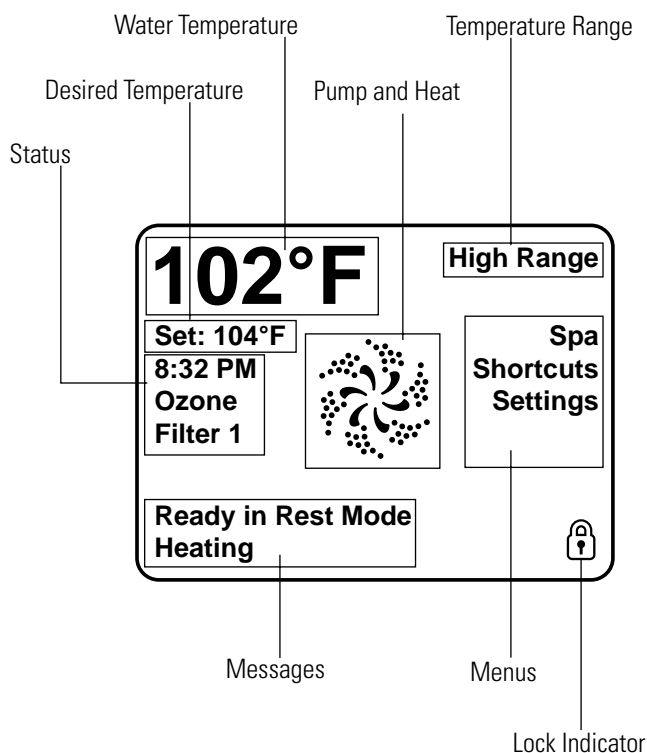

NAVIGATION

Navigating the entire menu structure is done with the 5 buttons on the control panel.

When a text item changes to white during navigation, that indicates the item is selected for action.

Operating or changing a selected item is generally done with the center or "Select" button.

The only item that can be changed on the left side of the Main Screen is the Set Temperature. Press the Left Arrow button to change the Set Temperature number to white. The Set Temperature can then be adjusted with the up and down buttons. Pressing the Select button or the Right Arrow button will save the new set temperature.

On the right side of the screen, the menu selections can be selected with the Up and Down Buttons. Use the Select Button to choose an item. Selecting one of these items will change to a different screen with additional controls.

PRESS-AND-HOLD

If an Up or Down button is pressed and held when the Set Temperature is selected, the temperature will continue to change until the button is released, or the Temperature Range limits are reached.

MESSAGES

At the bottom of the screen, messages may appear at various times. Some of these messages must be dismissed by the user.

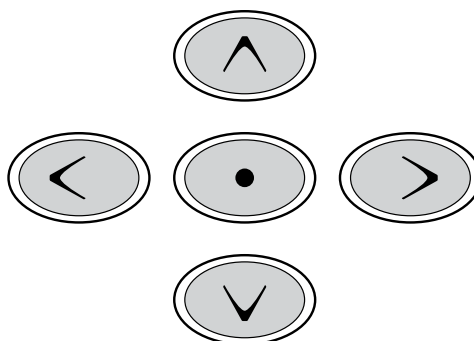

TP800, TP900 Priming Mode Start-up Sequence

PREPARATION AND FILLING

Fill the spa to its correct operating level. Be sure to open all valves and jets in the plumbing system before filling to allow as much air as possible to escape from the plumbing and the control system during the filling process.

After turning the power on at the main power panel, the top-side panel will display a splash, or startup screen.

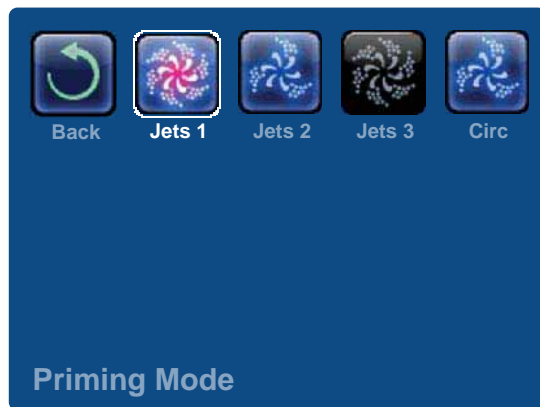

PRIMING MODE –

After the initial start-up sequence, the control will enter Priming Mode and display a Priming Mode screen. Only pump icons appear on the priming mode screen. The system will automatically return to normal heating and filtering at the end of the priming mode, which lasts 4-5 minutes.

During the priming mode, the heater is disabled to allow the priming process to be completed without the possibility of energizing the heater under low-flow or no-flow conditions. Nothing comes on automatically, but the pump(s) can be energized by selecting the “Jet” buttons.

If the spa has a Circ Pump, it can be turned on and off by pressing the “Circ Pump” button during Priming Mode. In addition, if the spa has a Circ Pump, it can be activated by pressing the dedicated “Light” button during Priming Mode when using a TP800.

Manually exit Priming Mode by pressing the “Exit” Button.

PRIMING THE PUMPS

As soon as the Priming Mode screen appears on the panel, select the “Jets 1” button once to start Pump 1 in low-speed and then again to switch to high-speed. Also, select the other pumps, to turn them on. The pumps should be running in high-speed to facilitate priming. If the pumps have not primed after 2 minutes, and water is not flowing from the jets in the spa, do not allow the pumps to continue to run. Turn off the pumps and repeat the process.

Note: Turning the power off and back on again will initiate a new pump priming session. Sometimes momentarily turning the pump off and on will help it to prime. Do not do this more than 5 times. If the pump(s) will not prime, shut off the power to the spa.

Important: A pump should not be allowed to run without priming for more than 2 minutes. Under NO circumstances should a pump be allowed to run without priming beyond the end of the 4-5 minute priming mode. Doing so may cause damage to the pump and cause the system to energize the heater and go into an overheat condition.

EXITING PRIMING MODE

You can manually exit Priming Mode by navigating to the “Back” button on the Priming Mode Screen. Note that if you do not manually exit the priming mode as described above, the priming mode will be automatically terminated after 4-5 minutes. Be sure that the pump(s) have been primed by this time.

Once the system has exited Priming Mode, the top-side panel will display the Main Screen, but the display will not show the temperature yet, as shown below. This is because the system requires approximately 1 minute of water flowing through the heater to determine the water temperature and display it.

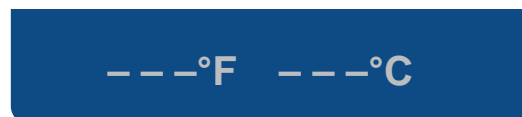

- M0[XX] numbers are Message Codes.
- A message with an asterisk [*] can be reset from the topside panel.

TP800, TP900 Spa Behavior

BE SURE TO SET THE TIME-OF-DAY

Setting the time-of-day is important for determining filtration times and other background features. "Set Time" will appear on the display if no time-of-day is set in the memory.

On the Settings Screen, select the Time-of-Day line. On the Time-of-Day screen, simply navigate right and left to select the Hour, Minutes, AM/PM and 12/24 Hour segments. Use the Up and Down Buttons to make changes.

SAVING SETTINGS

The Time-of-Day screen is a simple, editable screen that illustrates a feature of the control that applies to all other editable screens as well.

When changes are made, the icon to go "Back" changes to "Save" and a new icon for "Cancel" appears under the Save icon. Navigating to the left will highlight the Save icon, and navigating down from there will allow the user to cancel the pending change. Pressing the "Select" button will save or cancel the changes and go back to the previous screen.

NOTE: If power is interrupted to the system, Time-of-Day will be maintained for several days.

PUMPS

On the Spa Screen, select a "Jets" button once to turn the pump on or off, and to shift between low- and high-speeds if equipped. If left running, the pump will turn off after a time-out period. The pump 1 low-speed will time out after 30 minutes. The high-speed will time-out after 15 minutes.

On non-circ systems, the low-speed of pump 1 runs when the blower or any other pump is on. If the spa is in Ready Mode, Pump 1 low may also activate for at least 1 minute every 30 minutes to detect the spa temperature (polling) and then to heat to the set temperature if needed. When the low-speed turns on automatically, it cannot be deactivated from the panel, however the high speed may be started.

CIRCULATION PUMP MODES

Some spas may be manufactured with Circ Pump settings that allow programming filtration cycle duration. Some circ Modes are pre-programmed to operate 24 hours a day and are not programmable.

If your system is equipped with a circ pump, it may be configured to work in one of three different ways:

1. The circ pump operates continuously (24 hours) with the exception of turning off for 30 minutes at a time when the water temperature reaches 3°F (1.5°C) above the set temperature (most likely to happen in very hot climates).
 2. The circ pump stays on continuously, regardless of water temperature.
 3. A programmable circ pump will come on when the system is checking temperature (polling), during filter cycles, during freeze conditions, or when another pump is on.
- The specific Circulation Mode that is used has been determined by the Manufacturer and cannot be changed in the field.
 - Other device options may be available, like Blower, Light, Mist, etc.

FILTRATION AND OZONE

On non-circ systems, Pump 1 low and the ozone generator will run during filtration. On circ systems, the ozone will generally run with the circ pump, but can be limited to filtration cycles. The system is factory-programmed with one filter cycle that will run in the evening (assuming the time-of-day is properly set) when energy rates are often lower. The filter time and duration are programmable.

A second filter cycle can be enabled as needed.

At the start of each filter cycle, the water devices like blower, mist device (if these exist) and other pumps will run briefly to purge the plumbing to maintain good water quality.

FREEZE PROTECTION

If the temperature sensors within the heater detect a low enough temperature, then the water devices automatically activate to provide freeze protection. The water devices will run either continuously or periodically depending on conditions.

In colder climates, an optional additional freeze sensor may be added to protect against freeze conditions that may not be sensed by the standard sensors. Auxiliary freeze sensor protection acts similarly except with the temperature thresholds determined by the switch. See your dealer for details.

TP800, TP900 Adjusting Filtration

CLEANUP CYCLE (OPTIONAL)

When a pump or blower is turned on by a button press, a clean-up cycle begins 30 minutes after the pump or blower is turned off or times out. The pump and the ozone generator will run for 30 minutes or more, depending on the system. On some systems, you can change this setting. (See the Preferences section.)

MAIN FILTRATION

Using the same navigation and adjustment as Setting the Time, Filter Cycles are set using a start time and a duration. Each setting can be adjusted in 15-minute increments. The panel calculates the end time and displays it automatically.

FILTER CYCLE 2 - OPTIONAL FILTRATION

Filter Cycle 2 is OFF by default.

Simply navigate to the Filter Cycle 2 line by pressing the Right Navigation Button, and when "NO" is highlighted, press Up or Down to toggle Filter Cycle 2 on and off. When Filter Cycle 2 is ON, it can be adjusted in the same manner as Filter Cycle 1 by navigating to the right.

It is possible to overlap Filter Cycle 1 and Filter Cycle 2, which will shorten overall filtration by the overlap amount.

PURGE CYCLES

In order to maintain sanitary conditions, as well as protect against freezing, secondary water devices will purge water from their respective plumbing by running briefly at the beginning of each filter cycle.

If the Filter Cycle 1 duration is set for 24 hours, enabling Filter Cycle 2 will initiate a purge when Filter Cycle 2 is programmed to begin..

HOLD MODE - M037*

Hold Mode is used to disable the pumps during service functions like cleaning or replacing the filter. Hold Mode will last for 1 hour unless the mode is exited manually. If spa service will require more than an hour, it may be best to simply shut down power to the spa.

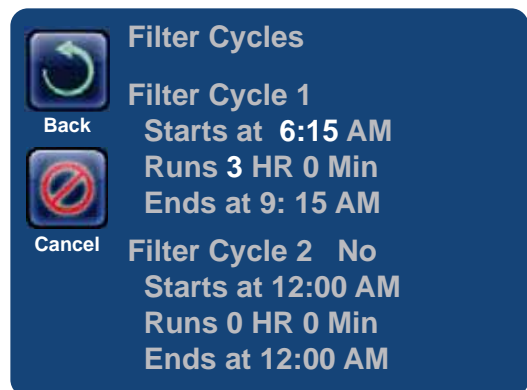
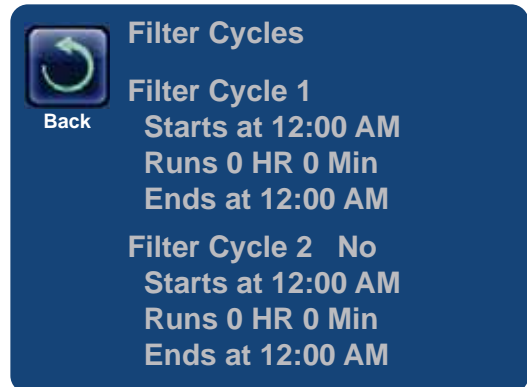

TP800, TP900 Panel Lock & Unlock

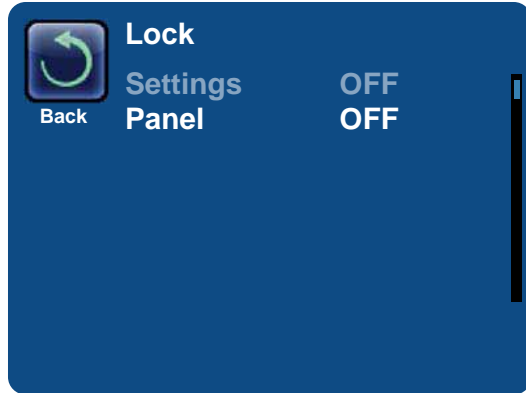

RESTRICTING OPERATION (LOCKING THE PANEL)

Main Screen > Settings > Lock

- The control can be restricted to prevent unwanted use or temperature adjustments.
- Locking the Panel prevents the controller from being used, but all automatic functions are still active.
- Locking the Settings allows Jets and other features to be used, but the Set Temperature and other programmed settings cannot be adjusted.
- Settings Lock allows access to a reduced selection of menu items. These include Set Temperature, Invert, Lock, Utilities, Information and Fault Log. They can be seen, but not changed or edited.

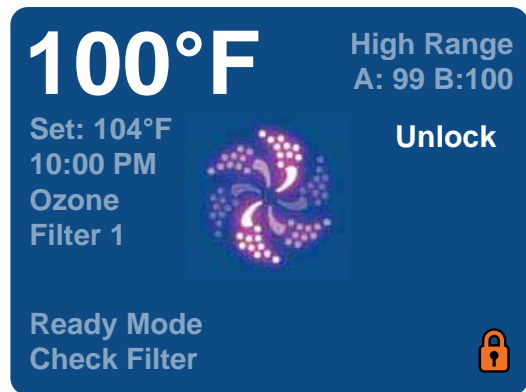

UNLOCKING THE PANEL

Main Screen > Unlock > [Right] > [Select] > [Select] > [Down]

- Unlocking the panel is accomplished from within the Lock Screen. The Unlock Sequence is the same for both Panel Lock and Settings Lock. However, the Panel must be unlocked before the Settings is unlocked.
- **NOTE:** When inside the Lock Screen, be sure that "Settings" or "Panel" is highlighted and not "Back" before using the key sequence below.

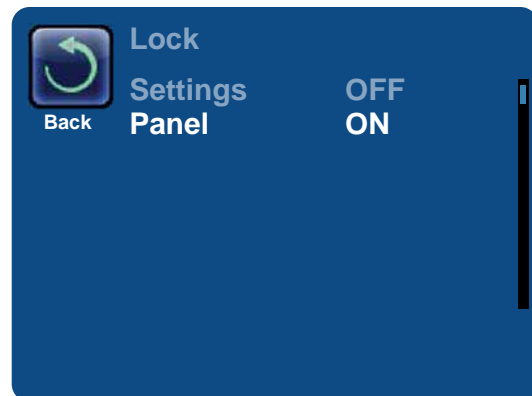

TP800, TP900 Sensor and System Related Messages

SYSTEM INFORMATION

The System Information Menu displays various settings and identification of the particular system. As each item in the menu is highlighted, the detail for that item is displayed at the bottom of the screen.

SOFTWARE ID: (SSID)

Displays the software ID number for the System.

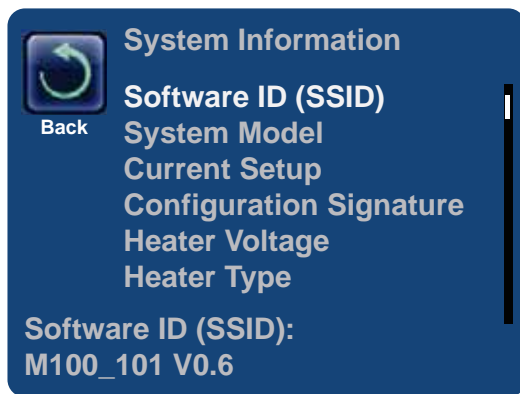

SYSTEM MODEL

Displays the Model Number of the System.

CURRENT SETUP

Displays the currently selected Configuration Setup Number.

CONFIGURATION SIGNATURE

Displays the checksum for the system configuration file.

HEATER VOLTAGE (FEATURE NOT USED ON CE RATED SYSTEMS.)

Displays the operating voltage configured for the heater.

HEATER WATTAGE AS CONFIGURED IN SOFTWARE (CE SYSTEMS ONLY)

Displays a heater kilowatt rating as programmed into the control system software (1-3 or 3-6).

HEATER TYPE

Displays a heater type ID number.

DIP SWITCH SETTINGS

Displays a number that represents the DIP switch positions of S1 on the main circuit board.

PANEL VERSION

Displays a number of the software in the topside control panel.

HEATER RELATED MESSAGES

THE WATER FLOW IS LOW – M016

There may not be enough water flow through the heater to carry the heat away from the heating element. Heater start up will begin again after about 1 min. See “Flow Related Checks” below.

THE WATER FLOW HAS FAILED* – M017

There is not enough water flow through the heater to carry the heat away from the heating element and the heater has been disabled. See “Flow Related Checks” below. After the problem has been resolved, you must press any button to reset and begin heater start up.

THE HEATER MAY BE DRY* – M028

Possible dry heater, or not enough water in the heater to start it. The spa is shut down for 15 min. Press any button to reset the heater start-up. See “Flow Related Checks” below.

THE HEATER IS DRY* – M027

There is not enough water in the heater to start it. The spa is shut down. After the problem has been resolved, you must clear the message to restart heater start up. See “Flow Related Checks” below.

THE HEATER IS TOO HOT* – M030

One of the water temp sensors has detected 118°F (47.8°C) in the heater and the spa is shut down. You must clear the message when water is below 108°F (42.2°C). See “Flow Related Checks” below.

FLOW-RELATED CHECKS

Check for low water level, suction flow restrictions, closed valves, trapped air, too many closed jets and pump prime.

Note: On some systems, even when spa is shut down by an error condition, some equipment may occasionally turn on to * or if freeze protection is needed.

TP800, TP900 Sensor and System Related Messages (cont.)

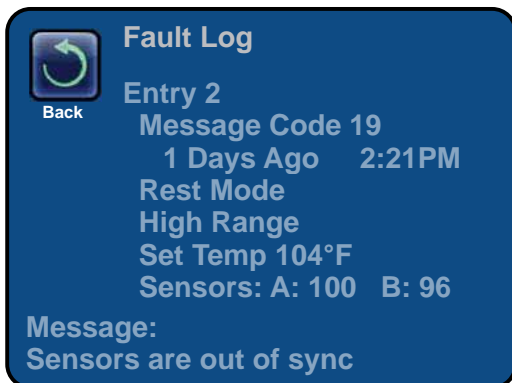
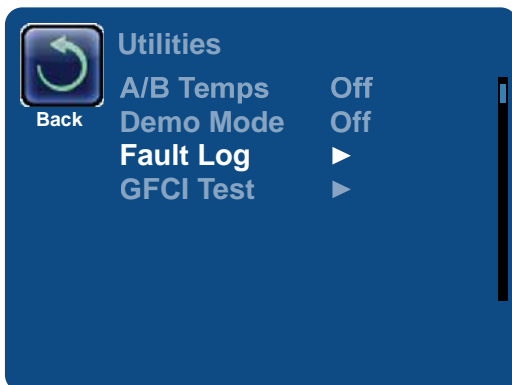
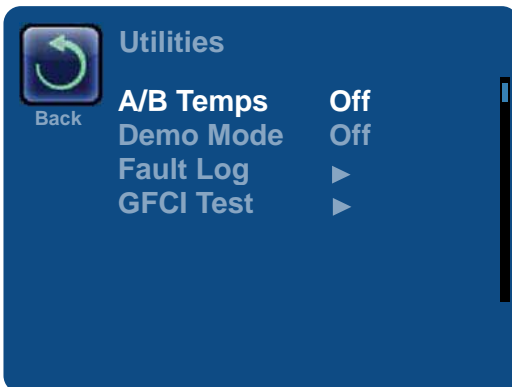
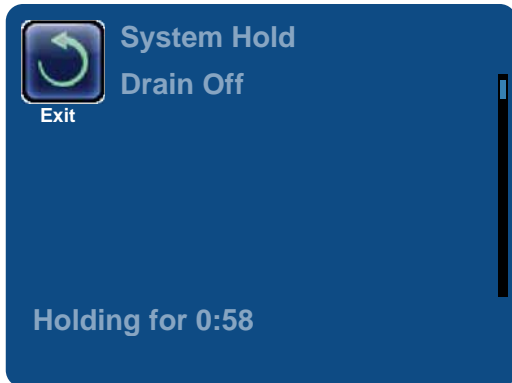

DRAIN MODE

[Main Screen > Settings > Hold > Drain](#)

Some spas have a special feature that allows Pump 1 to be employed when draining the water.

When available, this feature is a component of Hold mode.

UTILITIES MENU

[Main Screen > Settings > Utilities](#)

The Utilities Menu contains the following:

A/B TEMPS

When this is set to On, the temperature display will alternate to display temperature from Sensor A and Sensor B in the heater.

DEMO MODE

[Main Screen > Settings > Utilities > Demo Mode](#)

Demo mode is not always enabled, so it may not appear. This is designed to operate several devices in a sequence in order to demonstrate the various features of a particular hot tub.

FAULT LOG: TP800, TP900

[Main Screen > Settings > Utilities > Fault Log](#)

The Fault Log is a record of the last 24 faults that can be reviewed by a service tech.

GFCI TEST (FEATURE NOT AVAILABLE ON CE RATED SYSTEMS.)

GFCI Test is not always enabled, so it may not appear. This screen allows the GFCI to be tested manually from the panel and can be used to reset the automatic test feature. If the GFCI Test Feature is reset, the device will trip within 7 days.

TP800, TP900 Sensor and System Related Messages (cont.)

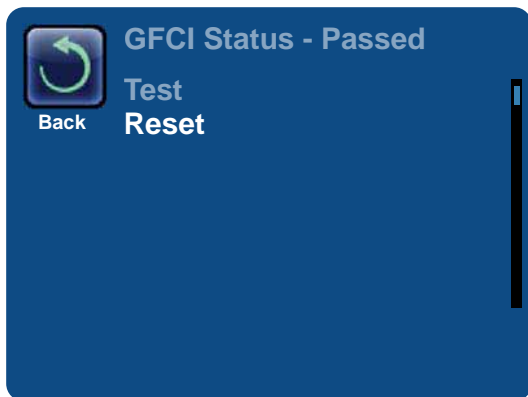
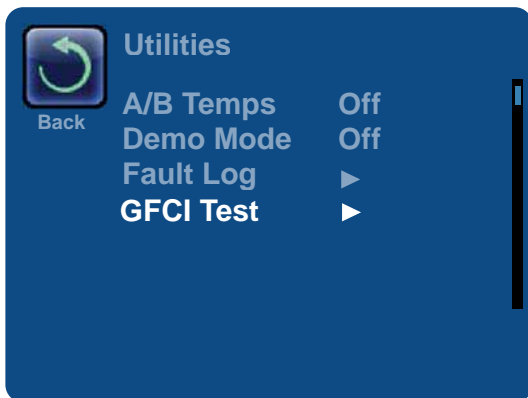
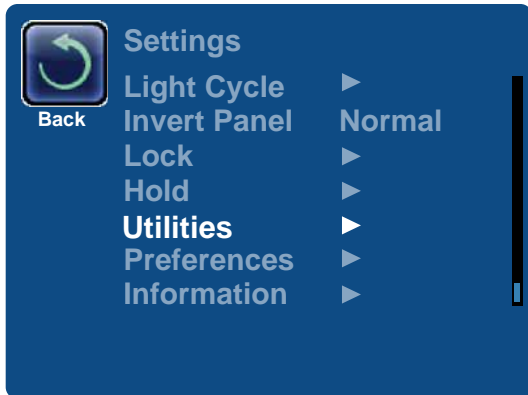

THE GROUND FAULT CIRCUIT INTERRUPTER (GFCI)
The Ground Fault Circuit Interrupter (GFCI) or Residual Current Detector (RCD) is an important safety device and is required equipment on a hot tub installation. ***(The GFCI Test Feature is not available on CE rated systems.)***

USED FOR VERIFYING A PROPER INSTALLATION
Your spa may be equipped with a GFCI Protection feature. If your spa has this feature enabled by the manufacturer, the GFCI Trip Test must occur to allow proper spa function.

Within 1 to 7 days after startup, the spa will trip the GFCI to test it. (The number of days is factory programmed.) The GFCI must be reset once it has tripped. After passing the GFCI Trip Test, any subsequent GFCI trips will indicate a ground fault or other unsafe condition and the power to the spa must be shut off until a service person can correct the problem.

FORCING THE GFCI TRIP TEST
The installer can cause the GFCI Trip Test to occur sooner by initiating it using the above menu.

The GFCI should trip within several seconds and the spa should shut down. If it does not, shut down the power and have a qualified person verify that the GFCI breaker is installed and that the circuit and spa are wired correctly. Verify the function of the GFCI with its own test button. Restore power to the spa and repeat the GFCI Trip Test.

Once the GFCI is tripped by the test, reset the GFCI and the spa will operate normally from that point. You can verify a successful test by navigating to the above menu. PASS should appear after a temp button is pressed from the GFCI Screen.

- WARNING:**
- The end-user must be told to expect this one-time test to occur and how to properly reset the GFCI.
 - If freezing conditions exist, the GFCI should be reset immediately or spa damage could result.

- CE PRODUCT:**
- CE registered systems do not have an RCD Test Feature due to the nature of the electrical service.
 - Some UL registered systems do not have the GFCI Test Feature activated.
 - The end-user must be trained how to properly test and reset the RCD.

TP800, TP900 Sensor and System Related Messages (cont.)

MOST MESSAGES AND ALERTS WILL APPEAR AT THE BOTTOM OF THE NORMALLY USED SCREENS.

Several alerts and messages may be displayed in a sequence. Some messages can be reset from the panel. Messages that can be reset will appear with a “right arrow” at the end of the message. This message can be selected by navigating to it at pressing the Select button.



Clean the filter ►

WATER TEMPERATURE IS UNKNOWN

---°F ---°C

After the pump has been running for 1 minute, the temperature will be displayed.

POSSIBLE FREEZING CONDITION

A potential freeze condition has been detected, or the Aux Freeze Switch has closed. All water devices are activated.

In some cases, pumps may turn on and off and the heater may operate during Freeze Protection. This is an operational message, not an error indication.

THE WATER IS TOO HOT – M029

The system has detected a spa water temp of 110°F (43.3°C) or more, and spa functions are disabled. System will auto reset when the spa water temp is below 108°F (42.2°C). Check for extended pump operation or high ambient temp.

SENSORS ARE OUT OF SYNC – M015

The temperature sensors MAY be out of sync by 2°F or 3°F.

SENSORS ARE OUT OF SYNC -- CALL FOR SERVICE* – M026

The temperature sensors ARE out of sync. The fault above has been established for at least 1 hour.

SENSOR A FAULT, SENSOR B FAULT – SENSOR A: M031, SENSOR B: M032

A temperature sensor or sensor circuit has failed. Call for Service

COMMUNICATIONS ERROR

The control panel is not receiving communication from the System.

TEST SOFTWARE INSTALLED

The Control System is operating with test software.

°F OR °C IS REPLACED BY °T

The Control System is in Test Mode.

PROGRAM MEMORY FAILURE* – M022

At Power-Up, the system has failed the Program Checksum Test. This indicates a problem with the firmware (operation program) and requires a service call.

THE SETTINGS HAVE BEEN RESET (PERSISTENT MEMORY ERROR)* – M021

Contact your dealer or service organization if this message appears on more than one power-up.

THE CLOCK HAS FAILED* – M020

CONFIGURATION ERROR - SPA WILL NOT START UP

THE GFCI TEST FAILED (SYSTEM COULD NOT TEST THE GFCI) – M036

(North America Only) May indicate an unsafe installation.

A PUMP MAY BE STUCK ON – M034

Water may be overheated. POWER DOWN THE SPA. DO NOT ENTER THE WATER.

HOT FAULT – M035

A Pump Appears to have been Stuck ON when spa was last powered. **POWER DOWN THE SPA. DO NOT ENTER THE WATER.**

TP800, TP900 Utilities Menu

THE UTILITIES MENU CONTAINS THE FOLLOWING:

PREFERENCES

The Preferences Menu allows the user to change certain parameters based on personal preference.

TEMP DISPLAY

Change the temperature between Fahrenheit and Celsius.

TIME DISPLAY

Change the clock between 12 hr and 24 hr display.

REMINDERS

Turn the reminder messages (like "Clean Filter") On or Off.

CLEANUP

Cleanup Cycle Duration is not always enabled, so it may not appear. When it is available, set the length of time Pump 1 will run after each use. 0-4 hours are available.

DOLPHIN II AND DOLPHIN III (APPLIES TO RF DOLPHIN ONLY)

When set to 0, no addressing is used. Use this setting for a Dolphin II or Dolphin III which is factory set for no address by default. When set between 1 and 7, the number is the address. (See *Optional Balboa Dolphin Remote* within this manual, or the Dolphin III domestic manual for details, Doc. No. 50211.)

COLOR OF BACKGROUND

Pressing the Select Button when Color is highlighted will cycle through 5 background colors available in the control.

LANGUAGE

Change the language displayed on the panel.

TP400, TP600 Standard Panel Operations - Main Screen - Navigation

Note: TP400 menu structure is similar to the TP600. This section is only for quick reference as it applies to troubleshooting. For complete menu operations, please refer to BVG user guide, document No. 40940 or user guide 42185 for simplified menus. TP400/TP600 error codes and fault messages are similar to TP800/TP900.

Navigation

Navigating the entire menu structure is done with 2 or 3 buttons on the control panel.



Some panels have separate **WARM** (Up) and **COOL** (Down) buttons, while others have a single **Temperature** button. In the navigation diagrams Temperature buttons are indicated by a single button icon.

Panels that have two Temperature buttons (Warm and Cool) can use both of them to simplify navigation and programming where a single Temperature icon is shown.

The **LIGHT** Button is also used to choose the various menus and navigate each section.

Typical use of the Temperature button(s) allows changing the Set Temperature while the numbers are flashing in the LCD.

Pressing the **LIGHT** button while the numbers are flashing will enter the menus.

The menus can be exited with certain button presses. Simply waiting for several seconds will return the panel operation to normal.

Power-up Screens

Each time the System powers up, a series of numbers is displayed. After the startup sequence of numbers, the system will enter Priming Mode (See Page 3).

Key

- Indicates Flashing or Changing Segment
- Indicates Alternating or Progressive Message - every 1/2 second
- ⬇️ A temperature button, used for "Action"
- ☀️ Light or dedicated "Choose" button, depending on control panel configuration
- Waiting time that keeps the last change to a menu item.
- ***** Waiting time (depends on menu item) that reverts to original setting and ignores any change to that menu item.

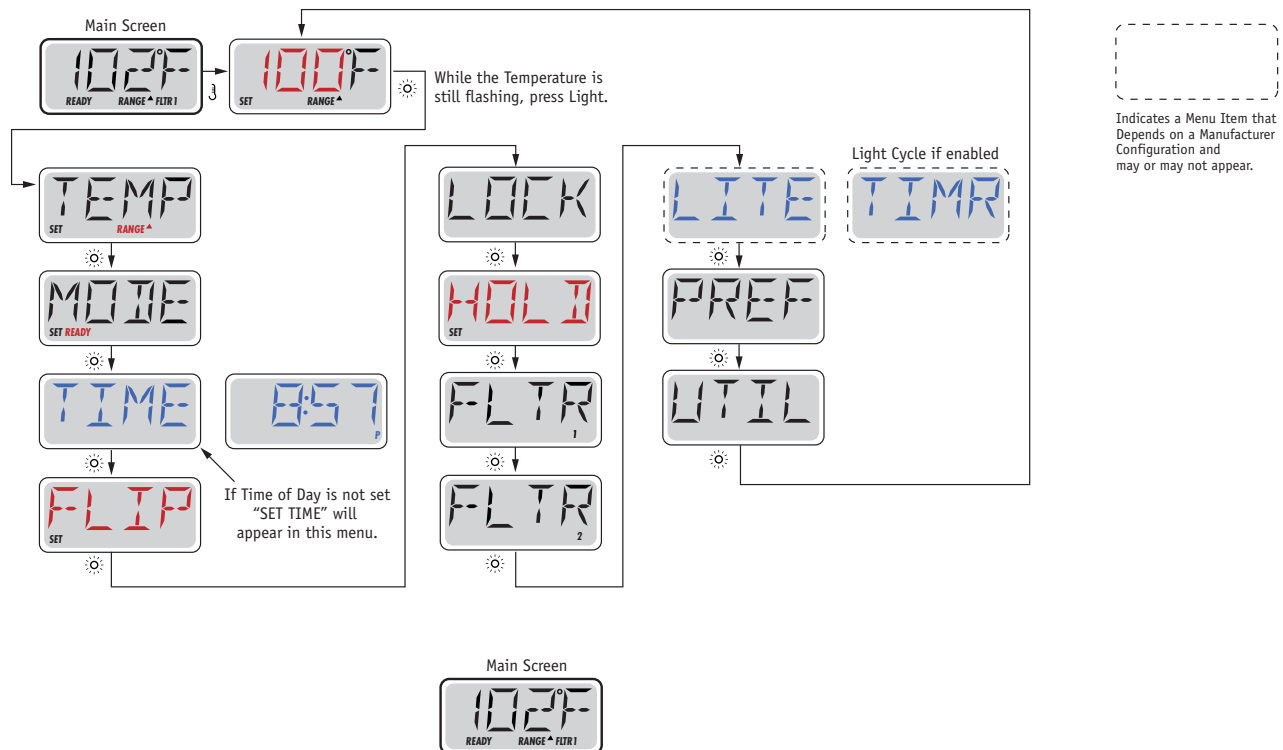

Waiting Several Seconds in the Main Menu will allow the display to revert to the Main Screen. Most changes are not saved unless Light ☀️ is pressed. Refer to Key above.

TP400, TP600 Panel Utilities Menu

If the system can power up, you have access to the Utilities and Fault Log menus.

Key

- Indicates Flashing or Changing Segment
- Indicates Alternating or Progressive Message - every 1/2 second
- A temperature button, used for "Action"
- Light or dedicated "Choose" button, depending on control panel configuration
- Waiting time that keeps the last change to a menu item.
- ***** Waiting time (depends on menu item) that reverts to original setting and ignores any change to that menu item.

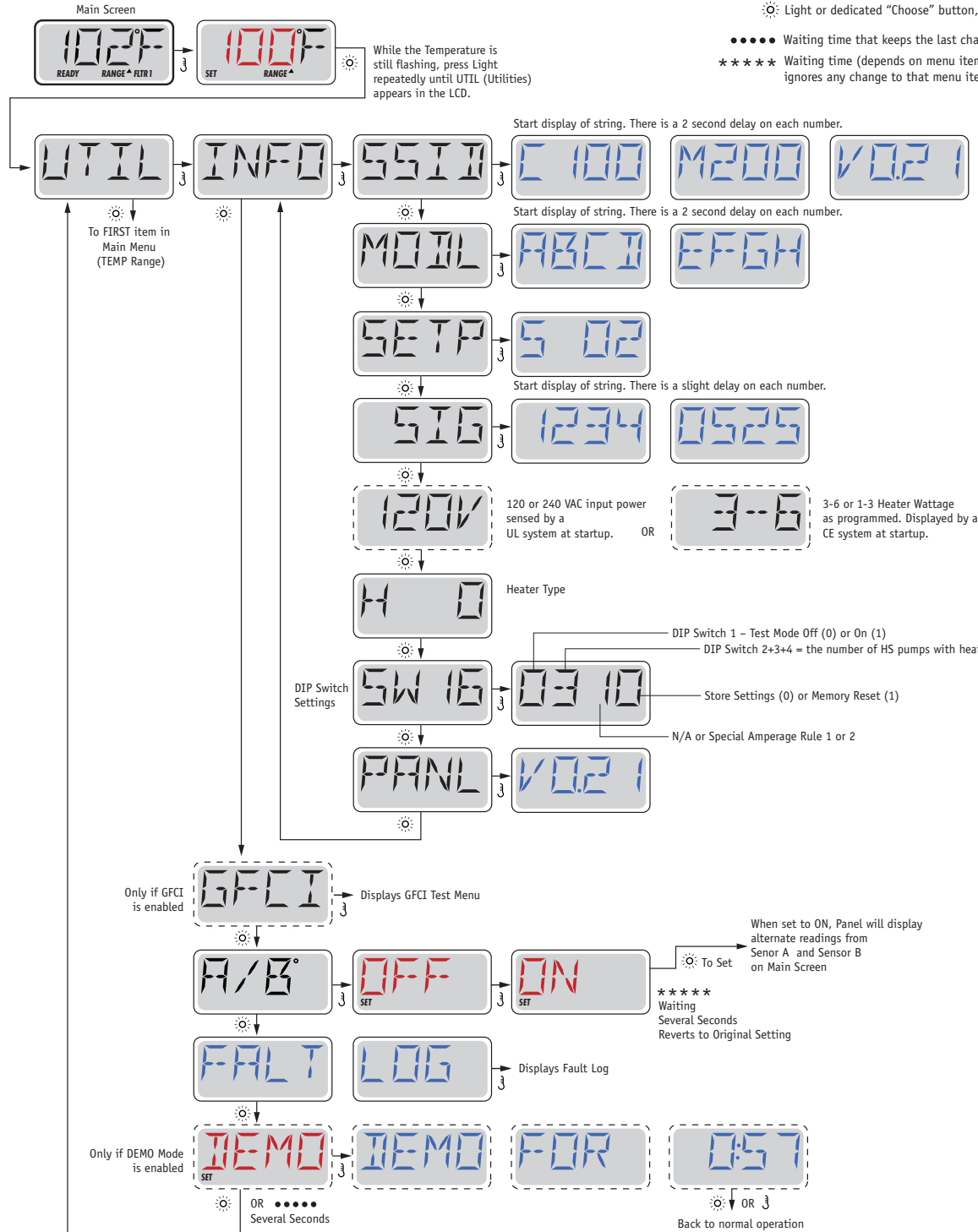

These strings will display once and return to the beginning. Press Temperature again to display the string again.

••••• Waiting 10 seconds will allow the screen to return to normal operation.

Indicates a Menu Item that Depends on a Manufacturer Configuration and may or may not appear.

TP400, TP600 Preparation and Priming

PREPARATION AND FILLING

Fill the spa to its correct operating level. Be sure to open all valves and jets in the plumbing system before filling to allow as much air as possible to escape from the plumbing and the control system during the filling process.

After turning the power on at the main power panel, the top-side panel display will go through specific sequences. These sequences are normal and display a variety of information regarding the configuration of the hot tub control.

PRIMING MODE – M019*



This mode will last for 4-5 minutes or you can manually exit the priming mode after the pump(s) have primed. Regardless of whether the priming mode ends automatically or you manually exit the priming mode, the system will automatically return to normal heating and filtering at the end of the priming mode. During the priming mode, the heater is disabled to allow the priming process to be completed without the possibility of energizing the heater under low-flow or no-flow conditions. Nothing comes on automatically, but the pump(s) can be energized by pushing the "Jet" buttons. If the spa has a Circ Pump, it can be activated by pressing the "Light" button during Priming Mode.

PRIMING THE PUMPS

As soon as the above display appears on the panel, push the "Jet" button once to start Pump 1 in low-speed and then again to switch to high-speed. Also, push the Pump 2 or "Aux" button, if you have a 2nd pump, to turn it on. The pumps will now be running in high-speed to facilitate priming. If the pumps have not primed after 2 minutes, and water is not flowing from the jets in the spa, do not allow the pumps to continue to run. Turn off the pumps and repeat the process.

Note: Turning the power off and back on again will initiate a new pump priming session. Sometimes momentarily turning the pump off and on will help it to prime. Do not do this more than 5 times. If the pump(s) will not prime, shut off the power to the spa.

Important: A pump should not be allowed to run without prim-

ing for more than 2 minutes. Under NO circumstances should a pump be allowed to run without priming beyond the end of the 4-5 minute priming mode. Doing so may cause damage to the pump and cause the system to energize the heater and go into an overheat condition.

EXITING PRIMING MODE

You can manually exit Priming Mode by pressing a "Temp" button (Up or Down). Note that if you do not manually exit the priming mode as described above, the priming mode will be automatically terminated after 4-5 minutes. Be sure that the pump(s) have been primed by this time.

Once the system has exited Priming Mode, the top-side panel will momentarily display the set temperature but the display will not show the temperature yet, as shown below. This is because the system requires approximately 1 minute of water flowing through the heater to determine the water temperature and display it.

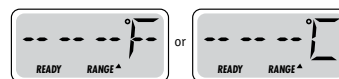

TP400, TP600 Message Codes

The following are messages and features that can appear on the TP400 and TP600 panels.

NOTE: LCD readouts may look slightly different than shown on screen.

MESSAGE CODES

(Found on the pages listed)

M0[XX] numbers are Message Codes 55

M015 62, 69

M016 59, 68

M017 59, 68

M019 68

M019* 55

M020 62, 69

M021 62, 69

M022 62, 69

M026 62, 69

M027 59

M028 59, 68

M029 62, 68

M030 59, 68

M031 69

M031, Sensor A: 62

M032 69

M032, Sensor B: 62

M033 68

M034 62, 69

M035 62, 69

M036 62, 69

M037* 57

DEMO (DEMO MODE)

Demo Mode is not always enabled, so it may not appear. This is designed to operate several devices in a sequence in order to demonstrate the various features of a particular hot tub.

INFO (SYSTEM INFORMATION SUB-MENU)

The System Information Menu displays various settings and identification of the particular system. As each item in the menu is highlighted, the detail for that item is displayed at the bottom of the screen.

SSID (SOFTWARE ID)

Displays the software ID number for the System.

MODL (SYSTEM MODEL)

Displays the Model Number of the System.

SETP (CURRENT SETUP)

Displays the currently selected Configuration Setup Number.

SIG (CONFIGURATION SIGNATURE)

Displays the checksum for the system configuration file.

HEATER VOLTAGE (FEATURE NOT USED ON CE RATED SYSTEMS)

Displays the operating voltage configured for the heater.

HEATER WATTAGE AS CONFIGURED IN SOFTWARE (CE SYSTEMS ONLY)

Displays a heater kilowatt rating as programmed into the control system software (1-3 or 3-6).

H _ (HEATER TYPE)

Displays a heater type ID number.

SW _ (DIP SWITCH SETTINGS)

Displays a number that represents the DIP switch positions of S1 on the main circuit board.

PANL (PANEL VERSION)

Displays a number of the software in the topside control panel.

GFCI (GFCI Test) (Feature not available on CE rated systems.)

GFCI Test is not always enabled, so it may not appear. This screen allows the GFCI to be tested manually from the panel and can be used to reset the automatic test feature. If the GFCI Test Feature is reset, the device will trip within 7 days.

TP400, TP600 Messages (cont.)

A / B (A/B SENSOR TEMPERATURES)

When this is set to On, the temperature display will alternate to display temperature from Sensor A and Sensor B in the heater.

FALT LOG (FAULT LOG)

The Fault Log is a record of the last 24 faults that can be reviewed by a service tech.

SCROLLING TP400/TP600 MESSAGES

The following messages will scroll across the TP400/TP600 panels. **NOTE:** LCD readouts may look slightly different than shown on screen.

RUN PMPS PURG AIR ----

PRIMING MODE – M019

Each time the spa is powered up, it will enter Priming Mode. The purpose of Priming Mode is to allow the user to run each pump and manually verify that the pumps are primed (air is purged) and water is flowing. This typically requires observing the output of each pump separately, and is generally not possible in normal operation. Priming Mode lasts 4 minutes, but you can exit it earlier by pressing any Temp button. The heater is not allowed to run during Priming Mode.

NOTE: If your spa has a Circ Pump, it will turn on with Jets 1 in Priming Mode. The Circ Pump will run by itself when Priming Mode is exited.

-- -- °F -- -- °C

Water Temperature is Unknown

After the pump has been running for 1 minute, the temperature will be displayed.

42 °F TOO COLD

Too Cold - Freeze Protection

A potential freeze condition has been detected, or the Aux Freeze Switch has closed, and all pumps and blower are activated. All pumps and blower are ON for at least 4 minutes after the potential freeze condition has ended, or when the aux freeze switch opens. In some cases, pumps may turn on and off and the heater may operate during Freeze Protection. This is an operational message, not an error indication.

WATR TOO HOT -- -- -- --

Water is too Hot (OHS) – M029

One of the water temp sensors has detected spa water temp 110°F (43.3°C) and spa functions are disabled. System will auto reset when the spa water temp is below 108°F (42.2°C). Check for extended pump operation or high ambient temp.

SFTY TRIP -- -- -- --

Safety Trip - Pump Suction Blockage* – M033

The Safety Trip error message indicates that the vacuum switch has closed. This occurs when there has been a suction problem or a possible entrapment situation avoided. (Note: not all spas have this feature.)

HTR FLOW LOSS -- -- -- --

Heater Flow is Reduced (HFL) – M016

There may not be enough water flow through the heater to carry the heat away from the heating element. Heater start up will begin again after about 1 min. See "Flow Related Checks" below.

HTR FLOW FAIL -- -- -- --

Heater Flow is Reduced (LF)* – M017

There is not enough water flow through the heater to carry the heat away from the heating element and the heater has been disabled. See "Flow Related Checks" below. After the problem has been resolved, you must press any button to reset and begin heater start up.

HTR MAY BE DRY -- -- -- -- WAIT -- -- -- --

Heater May be Dry (dr)* – M028

Possible dry heater, or not enough water in the heater to start it. The spa is shut down for 15 min. Press any button to reset the heater start-up. See "Flow Related Checks" below.

HTR TOO HOT -- -- -- --

HTR is too Hot (OHH)* M030

One of the water temp sensors has detected 118°F (47.8°C) in the heater and the spa is shut down. You must press any button to reset when water is below 108°F (42.2°C). See "Flow Related Checks" below.

PRES BTTN TO RSET -- -- -- --

A Reset Message May Appear with other Messages.

Some errors may require power to be removed and restored.

FLOW-RELATED CHECKS

Check for low water level, suction flow restrictions, closed valves, trapped air, too many closed jets and pump prime.

On some systems even when spa is shut down, some equipment may occasionally turn on to continue monitoring temperature or if freeze protection is needed.

102°F SNSR BAL-- ANCE

Sensor Balance is Poor – M015

The temperature sensors MAY be out of sync by 2°F or 3°F.

SNSR SYNC -- -- -- -- CALL FOR SRVC -- -- -- --

Sensor Balance is Poor* – M026

The temperature sensors ARE out of sync. The Sensor Balance is Poor fault has been established for at least 1 hour.

SNSR A -- -- -- -- CALL FOR SRVC -- -- -- --

SNSR B -- -- -- -- CALL FOR SRVC -- -- -- --

Sensor Failure – Sensor A: M031, Sensor B: M032

A temperature sensor or sensor circuit has failed.

NO COMM

No Communications

The control panel is not receiving communication from the System.

BETA VER-- SION -- -- -- --

Pre-Production Software

The Control System is operating with test software.

102 °T

°F or °C is replaced by °T

The Control System is in Test Mode.

MEM FAIL -- -- -- --

Memory Failure - Checksum Error* – M022

At Power-Up, the system has failed the Program Checksum Test. This indicates a problem with the firmware (operation program) and requires a service call.

MEM RSET -- -- -- --

Memory Warning - Persistent Memory Reset* – M021

Appears after any system setup change. Contact your dealer or service organization if this message appears on more than one power-up, or if it appears after the system has been running normally for a period of time.

CLOK FAIL -- -- -- --

Memory Failure - Clock Error* – M020

Not Applicable on the BP1500.

CNFG FAIL -- -- -- --

Configuration Error - Spa will not Start Up

GFCI FAIL -- -- -- --

GFCI Failure - System Could Not Test/Trip the GFCI – M036

NORTH AMERICA ONLY. May indicate an unsafe installation.

STUK PUMP -- -- -- --

A Pump Appears to be Stuck ON – M034

Water may be overheated. POWER DOWN THE SPA. DO NOT ENTER THE WATER.

HOT FALT -- -- -- -- CALL FOR SRVC -- -- -- --

A Pump Appears to have been Stuck ON when spa was last powered – M035

POWER DOWN THE SPA. DO NOT ENTER THE WATER.

TP400, TP600 Utilities Fault Log Menu

THE FAULT LOG

The Fault Log stores up to 24 events in memory and they can be reviewed under the Fault Log Menu. The Fault Log is a record of the last 24 faults that can be reviewed by a service tech.

Each event captures a Fault Message Code, how many days have passed since the fault, Time of the fault, Set Temperature during the fault, and Sensor A and B temperatures during the fault. The Fault Log is also available from the Test Menu (in Test Mode).

- Pressing TEMP at any fault event reveals a Message Code
- Continuing to press TEMP reveals additional information for that specified numbered fault event.
- Waiting 30 seconds inside the fault log menu allows the screen to return to normal operation.

FAULT LOG MESSAGE CODES: TP400, TP600

- MXXX: Fault Message Code
- DZZZ: How many days have passed since the fault
- Time of the fault
- Set Temperature during the fault
- Sensor A Temperature during the fault
- Sensor B Temperature during the fault

Key

- Indicates Flashing or Changing Segment
- Indicates Alternating or Progressive Message - every 1/2 second
- ⏏ A temperature button, used for "Action"
- ☀ Light or dedicated "Choose" button, depending on control panel configuration
- Waiting time - varies depending on function

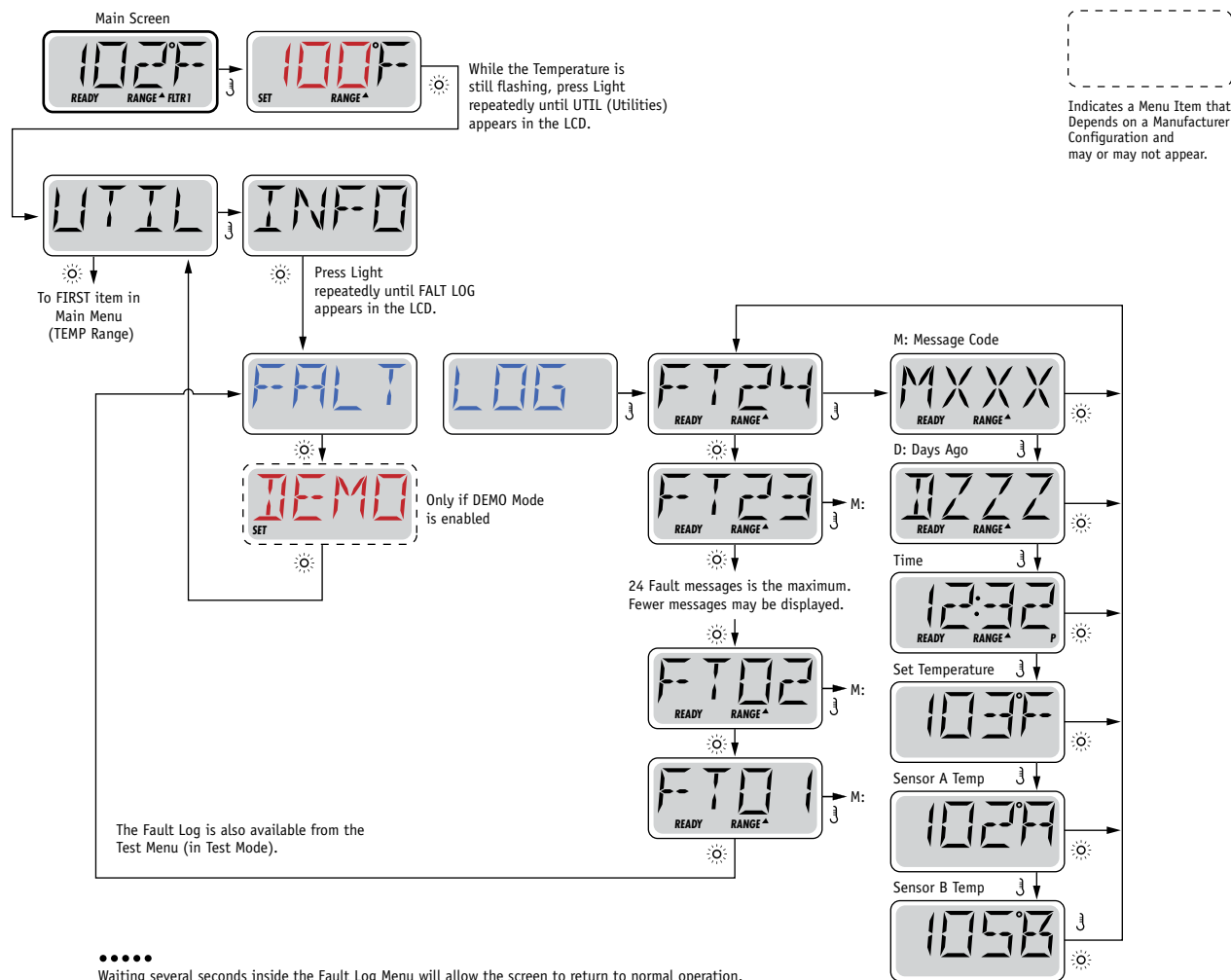

•••••
Waiting several seconds inside the Fault Log Menu will allow the screen to return to normal operation.

TP400, TP600 Utilities Menu - GFCI Test Feature

Not Available on CE Rated Systems.

A GFCI is an important safety device and is required equipment on a hot tub installation.

Your spa may be equipped with a GFCI Protection feature. (UL rated systems only.) If your spa has this feature enabled by the manufacturer, the GFCI Trip Test must occur to allow proper spa function.

Within 1 to 7 days after startup, the spa will trip the GFCI to test it. (The number of days is factory programmed.) The GFCI must be reset once it has tripped. After passing the GFCI Trip Test, any subsequent GFCI trips will indicate a ground fault or other unsafe condition and the power to the spa must be shut off until a service person can correct the problem.

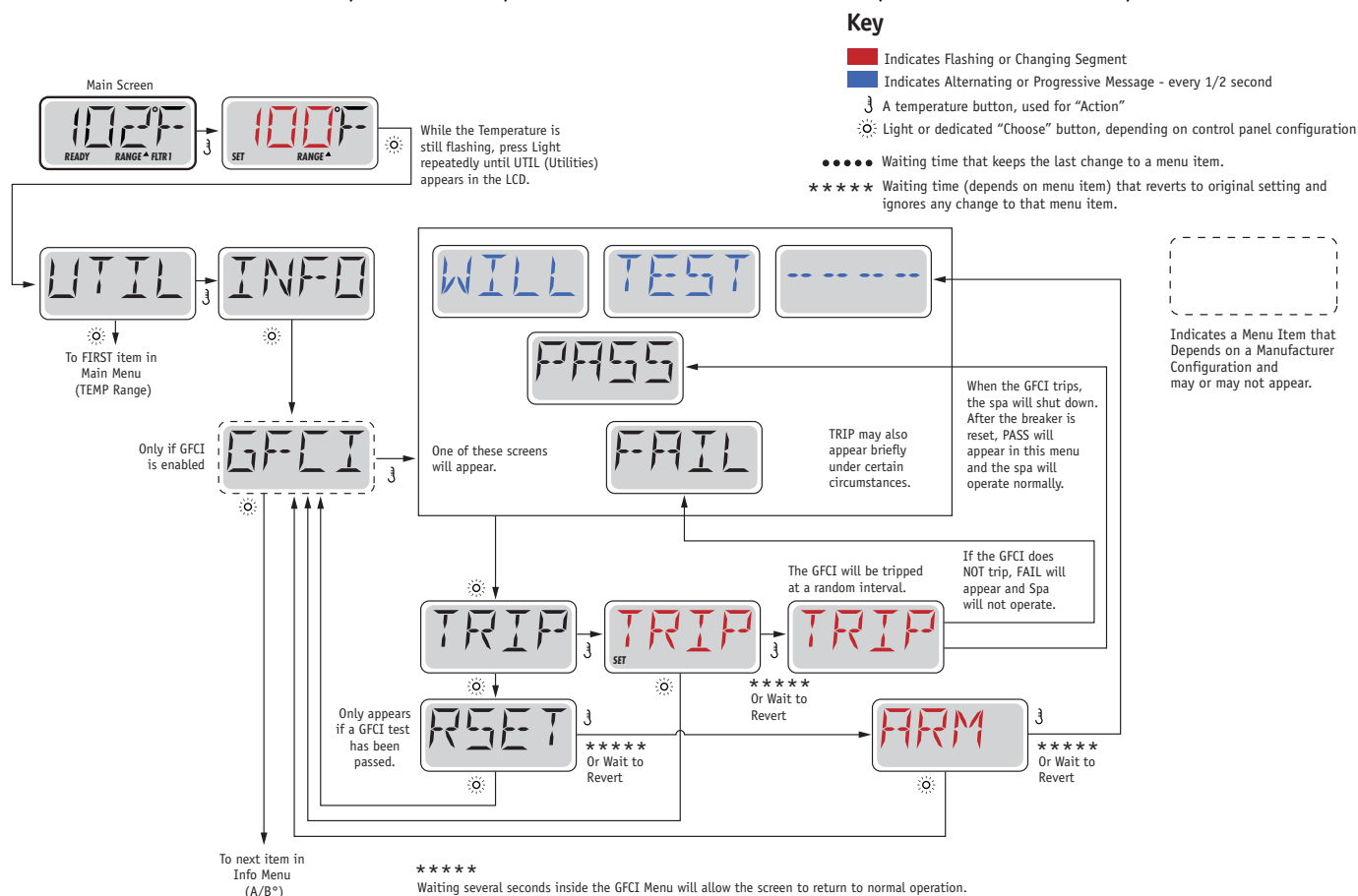

Forcing the GFCI Trip Test

The installer can cause the GFCI Trip Test to occur sooner by initiating it using the above menu.

The GFCI should trip within several seconds and the spa should shut down. If it does not, shut down the power and manually verify that a GFCI breaker is installed and that the circuit and spa are wired correctly. Verify the function of the GFCI with its own test button. Restore power to the spa and repeat the GFCI Trip Test.

Once the GFCI is tripped by the test, reset the GFCI and the spa will operate normally from that point. You can verify a successful test by navigating to the above menu. PASS should appear after a temp button is pressed from the GFCI screen.

The end-user must be trained to expect this one-time test to occur and how to properly reset the GFCI.

Warning:

If freezing conditions exist, a GFCI should be reset immediately or spa damage could result. The end user should always trained to test and reset the GFCI on a regular basis.

TP400, TP600 Simplified vs. Standard Panel Operations

SIMPLIFIED MENUS

Simplified Menus is an option that manufacturers (OEM's) offer to their end users in order to provide an easier to navigate menu. A simplified menu structure does not have extended features such as Utilities, Restricting Operation, Unlocking, and so on; yet, provides basic spa operations that satisfy the needs of end users. Navigating the menu structure is similar for both standard and simplified menus, which is done using two or three buttons on the control panel.

All TP600 and TP400 panels are compatible with simplified menus and standard menus, and can access Test Mode. Regardless of menu structure, test modes have full functionality. The control panel user guides for standard and simplified menus are different: Balboa user guide 40940 describes standard menus; user guide 42185 describes simplified menus.

Menu attributes are embedded within the spa control system at the factory. Swapping out one panel with another will not change a simplified menu to a standard menu, and vice versa. For the system to be changed from one menu structure to another is dependent on whether that option was programmed into the system at the time of manufacturing.

CHANGING MENUS THROUGH CONFIGURATIONS

If the option of an alternate menu structure is available, then it is possible to change the simplified menu to a standard menu, and vice versa. A technician must refer to the Tech Sheet of that particular system to see what configuration (if any) is available.

For instance, if a technician plans to install or modify a Sunrise Spas BP 240V system (in this example), and that system has standard menus that he wishes to change to simplified menus, he would refer to Tech Sheet SR240BP5 (No. 56415-97, Rev. A).

Page two provides information in the System Revision History: "*240V-only version with both Simplified Menus and Full Menus*". The next giveaway of dual menu options is the section headers on the following pages. See below.

- Page 3: An option is given to use Setup 1, or Setup 7.
- Below that, an option is given to use Setup 2, or Setup 8.
- Page 4: An option is given to use Setup 3, or Setup 9.

In these three examples (out of six possible dual menu options available for this system), Setups 1, 2, or 3 could be chosen for a simplified menu. Of course, the option is open to configure a counterpart control system to standard menus by choosing Setup 7, 8, or 9 respectively.

Headings of Setups 1, 2, & 3 in Tech Sheet SR240BP5 (12-05-12, Rv. A)

Page 3: **Setup 1 – Simplified Menu (with Flip) Setup 7 – Full Menu**

Page 3: **Setup 2 – Simplified Menu (with Flip) Setup 8 – Full Menu**

Page 4: **Setup 3 – Simplified Menu (with Flip) Setup 9 – Full Menu**

A Simplified Main Menu (Doc No. 42185B)

Main Menus

Navigation

Navigating the entire menu structure is done with 2 or 3 buttons on the control panel.



Some panels have separate **WARM** (Up) and **COOL** (Down) buttons, while others have a single **Temperature** button. In the navigation diagrams Temperature buttons are indicated by a single button icon. Panels that have two Temperature buttons (Warm and Cool) can use both of them to simplify navigation and programming where a single Temperature icon is shown.

The **LIGHT** Button is also used to choose the various menus and navigate each section.

Typical use of the Temperature button(s) allows changing the Set Temperature while the numbers are flashing in the LCD. Pressing the **LIGHT** button while the numbers are flashing will enter the menus.

The menus can be exited with certain button presses. Simply waiting for several seconds will return the panel operation to normal.

Power-up Screens

Each time the System powers up, a series of numbers is displayed. After the startup sequence of numbers, the system will enter Priming Mode (See Page 3).

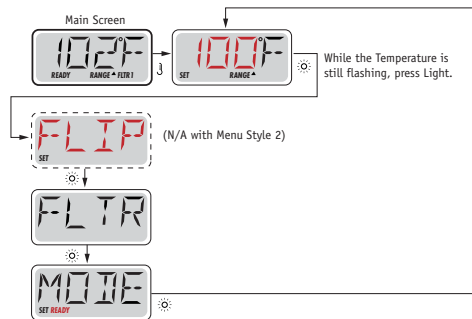

Key

- Indicates Flashing or Changing Segment
- Indicates Alternating or Progressive Message - every 1/2 second
- ⌵ A temperature button, used for "Action"
- ☉ Light or dedicated "Choose" button, depending on control panel configuration
- Waiting time that keeps the last change to a menu item.
- ***** Waiting time (depends on menu item) that reverts to original setting and ignores any change to that menu item.

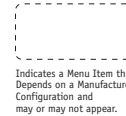

Waiting Several Seconds in the Main Menu will allow the display to revert to the Main Screen. Most changes are not saved unless Light ☉ is pressed. Refer to Key above.

A STANDARD MAIN MENU (DOC NO. 409411)

Both panels can be navigated using 2 or 3 buttons.

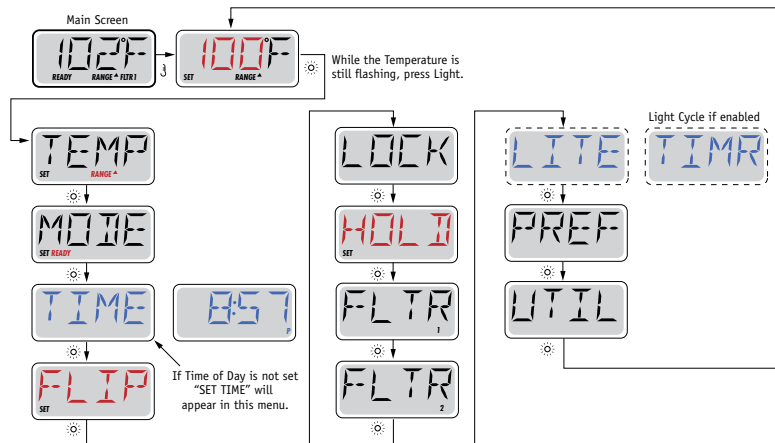

Waiting Several Seconds in the Main Menu will allow the display to revert to the Main Screen. Most changes are not saved unless Light ☉ is pressed. Refer to Key above.

Supplemental Information - Optional Balboa Dolphin™ Remote

THE DOLPHIN™ REMOTE

The Dolphin Remote works much the same way as your entertainment remote at home does; yet, it's designed to control pumps, blowers, and any option that you have on your pool or spa--including entertainment equipment.

HOW THE DOLPHIN WORKS

The Dolphin communicates with a Dolphin RF Receiver (or IR Receiver). The receiver is wired into the Control System.

1. Mount the Dolphin receiver module in a vertical position with the molded arrow pointing up.
2. Plug the receiver's connector into the 6-pin connector J40 labeled REMOTE located within the Control System box.
3. In order for the Dolphin to communicate, it must be assigned an "address" that the Control Center and Dolphin recognize, and allows both the Dolphin and specific equipment (blower, jets, or stereo for example) to "talk" to each other. (The factory default is zero, or no address.)
4. When set to 0, no addressing is used. Use this setting for a Dolphin III, which is factory set for no address by default. The Dolphin has a total of eight addresses: zero, and 1-7.



Dolphin



Dolphin Receiver

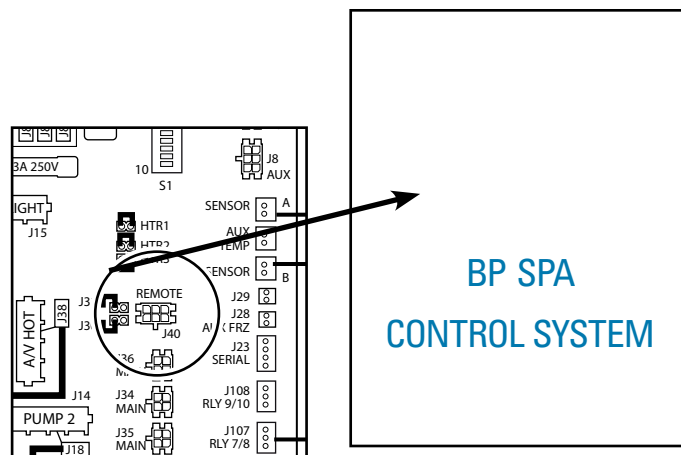

Optional Balboa Dolphin™ Remote (cont.)

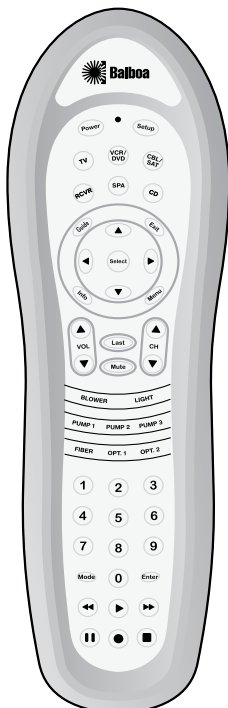
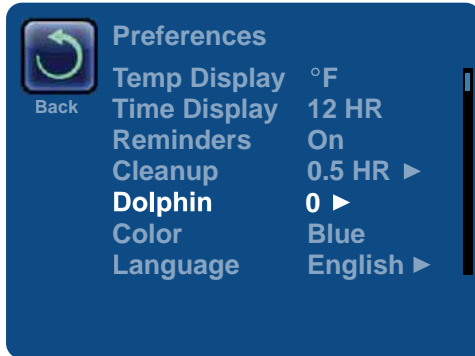

Dolphin III (50211)
Dolphin III CE (50212)

ASSIGNING A NEW ADDRESS TO THE DOLPHIN

In some instances you may want to reset the address of your Dolphin. You'll need to match that new address in the control system and that of your Dolphin.

Step 1: Addressing your Colossus through your control panel:

Main Screen > Settings (scroll to Preferences) > Preferences > Dolphin > Dolphin Screen

Use the arrow key to change the address to 5 (in this example). Exit with Arrow Left key.

Step 2: Addressing your Dolphin:

1. a) Press the SPA Button on the Dolphin once.
b) Press and hold SETUP until the LED blinks once.
c) Hold it until it blinks twice.
2. Enter one of the set up codes below:
Set Up Code = [Spa Address]
0000 = [0] (no address)
0008 = [1]
0080 = [2]
0088 = [3]
0800 = [4]
0808 = [5]
0880 = [6]
0888 = [7]
3. If the code is entered correctly, the LED will blink twice. (Refer to the Dolphin manuals for more details.)

SAVING YOUR DOLPHIN ADDRESS

For future reference, make a note of the address for your records. Keep in mind that you may have to change the address if there are conflicts with your equipment. Also, the address may have to be reentered after servicing.

DOLPHIN MANUAL

Dolphin III manuals can be found on our site: www.balboawatergroup.com

Click on "Spa Products" > "Wireless Remotes"

- Dolphin III manual (domestic) Document No. 42012
- Dolphin III manual (CE) is Document No. 42013

DOLPHIN REMOTES

- Dolphin III (domestic), Document No. 50211
- Dolphin III, CE (no RF), Document No. 50212

Spa Guidelines to Keep in Mind

Below are guidelines when designing replacing an older control system, or if designing a new spa system. This information is included in order to offer more insight into spa plumbing and mechanics.

1. The heater requires at least 20 Gallons per Minute (GPM) of flow for proper function.
2. Some systems may require at least 25 GPM.
3. The suction system for the 2-speed pump or for the circ pump must be dedicated. There must not be any other pumps connected to this suction system.
4. The suction system for the 2-speed pump or for the circ pump must include the following:
 - a. 2 suction fittings, or
 - b. 1 suction fitting and a skimmer.
5. If the suction system for the 2-speed pump or for the circ pump includes a filter, it is desirable that the filter incorporate a by-pass around the filter cartridge that opens when the cartridge gets dirty. (Spring tension holding the by-pass valve closed must be overcome by the vacuum of the pump.) This by-pass should be capable of flowing a minimum of 20 GPM during the low speed operation of the 2-speed pump or during circ pump operation with the cartridge 100% blocked. The inclusion of a suction fitting appropriately plumbed into the suction circuit in conjunction with a vacuum filter may also meet this requirement.
6. The pressure system for the 2-speed pump or for the circ pump must be dedicated. There must not be any other pumps connected to this pressure system.
7. The pressure system for the 2-speed pump or for the circ pump must discharge water freely into the spa.
8. If the pressure system for the 2-speed pump includes a diverter valve, or a diverter jet, there must not be an "off" position that would stop water flow from the pump or any other position that would throttle or reduce water flow from the pump.
9. If the pressure system for the 2-speed pump includes flow adjustable jets that can be 100% closed, at least 2 non-adjustable jets must be included in each possible inlet circuit so that a minimum of 20 GPM can flow during low pump operation with all the jets closed. Any other means of by-passing flow around the closed jets is acceptable as long as the by-pass means is down stream from the heater and allows a minimum of 20 GPM to flow through the heater during low speed operation.
10. If the pressure system for the 2-speed pump includes flow adjustable jets that do not close 100%, at least 20 GPM must flow during low speed operation through each possible inlet circuit with all the jets closed.
11. If the pressure system for a 2-speed pump or for a circ pump includes a filter, the filter must be equipped with a by-pass around the cartridge that opens when the cartridge gets dirty. (Spring tension holding the by-pass valve closed must be overcome by the pressure of the pump.) This by-pass must be capable of flowing a minimum of 20 GPM during low pump operation with the cartridge 100% blocked.
12. If the pressure system for a 2-speed pump or for a circ pump includes branch circulation lines such as circuits intended to operate ozone injection systems, these branch circulation lines must be connected downstream from the heater.
13. Avoid inter-connection of the plumbing circuits for the 2-speed pump or for the circ pump with other pumps in the spa plumbing system for the purpose of freeze protection. The Colossus control system will provide freeze protection. There is also provision for remote sensing freeze protection if required.
14. Position inlets and jets in the spa so that they do not direct water flow towards suction fittings or skimmers. This will avoid a "thermal short circuit" and prevent excessive heater and pump cycling.
15. If service valves are a part of the circulation system for the 2-speed pump or for the circ pump, be sure to use valves that incorporate a means of "locking" in the open position.
16. If the 2-speed pump or the circ pump is replaced in the field by service personnel, the replacement used must equal or exceed the hydraulic specifications of the original pump.
17. To assure adequate performance, the spa plumbing must be 1-1/2" minimum. The use of 2" is highly recommended. Either schedule 40 or flexible PVC pipe is acceptable.
18. It is recommended that shut-off valves be installed in the suction and discharge lines.

Glossary

CIRC PUMP (OR CIRCULATION PUMP)

Low horse power pump designated especially for maintenance of filtration and heating. It often runs all day.

CLEAN-UP (OR PURGE) CYCLE

An action designed to circulate water to maintain sanitary conditions. Pumps or blowers purge standing water to prevent the water from becoming stagnant.

FILTRATION CYCLE

Period of time designated to filter the system. Oftentimes there are two filter cycles, 12 hours apart, and designated as F1 and F2.

FREEZE PROTECTION

A safety feature detecting water or air temperature approaching freezing. Once a set low temperature is reached, an action is often initiated automatically. Oftentimes pumps will start to keep water circulating in all plumbing and the heater may operate.

GFCI

A device intended to protect people in the event of an electrical malfunction. Spa owners should know how to test the GFCI as routine maintenance.

PREFERENCES

Programmed events according to personal preferences.

SSID

Software Self Identification (or, System Panel ID)

PROGRAMMING

Setting an order and time for planned events, such as filter times, clean-up cycle, etc.

PRIMING MODE

Act of water flow through the plumbing to purge air from the spa system. Normally, priming mode can be bypassed. The priming mode is necessary only if the spa is refilled and if there's the possibility of air being in the system.

WHAT PRIMING MODE DOES:

Each time the spa is powered up, it will enter Priming Mode. The

purpose of Priming Mode is to allow the user to run each pump and manually verify that the pumps are primed (air is purged) and water is flowing. This typically requires observing the output of each pump separately, and is generally not possible in normal operation. Priming Mode lasts 4 minutes, but you can exit it earlier by pressing any Temp button. The heater is not allowed to run during Priming Mode. NOTE: If your spa has a Circ Pump, it will turn on with Jets 1 in Priming Mode. The Circ Pump will run by itself when Priming Mode is exited.

Index

Symbols

1, DIP Switch 44
1, Switch 45
6AWG copper conductors 20
6-pin connector J40 74
30 - 35 in lbs. torque 52
30A pump fuses 38
120V Amp Draw 23, 42
120V Draw 23
120V Watts 23
230V Amp Draw 23
230V Watts 23
240V Amp Draw 23, 42
240V Draw 23
240V Watts 23
30344 sensor wire 7
42012, Document No. 75
42013, Document No. 75
50211, Document No. 75
50212, Document No. 75
---°F ---°C 62
°F or °C is replaced by °T 44
°T 46
°T, °F or °C is replaced by 44

A

A / B (A/B Sensor Temperatures) 68
A/B Sensor 44
A/B Sensor Temperatures 44
A/B Temps 60
Acceptable Heater Amperage Draw Ranges 23
Acceptable Heater Ohm (Ω) Ranges 23, 34
Acceptable Ranges for Testing 23
Access, Test Menu 44
access to the power board 41
address, Assigning a new 75
Address, Dolphin 75
Addressing your Dolphin 75
Address, Spa 75
Adequate drainage 2
Always test continuity of a fuse 19

ammeter, amperage draw with an 19
AMP cord 43
amperage at the red pump wire 19
amperage draw limits 19
Amperage Draw Ranges 23
amperage draw with an ammeter 19
Amperage Heater Test BP500 42
Amperage Heater Test BP2000 42
appliance, continuous duty 3
arrow, right 62
A, Sensor 44, 60
Assigning a new address 75
asterisk, message with an 55
Auxiliary freeze sensor 56
A vs B or T vs H 48

B

background colors 63
ball valves 52
black blower wire 19
Blockage*, Pump Suction 68
blower problem 19
board, access to the power 41
Board, Compatibility on Dual 51
board, expander 38, 50
Board, Expander 24
board, isolate the logic 41
board, Logic 41
Board, Logic 41
board, newer revision 51
board problem 49
board, reinstalling the 51
board, Torque main 51
BP500, Amperage Heater Test 42
BP500, Sensor Location 41
BP2000, Amperage Heater Test 42
BP2000 board without wires 51
BP2000/BP2100, Heater Connector on 52
BP, TP panels work with all 8
breaker, GFCI 61
B, Sensor 44, 60
button, test 61

C

Calls, Service 7
Canadian Electric Code 3
Cause 22
changes, wiring 44
Change the setup 44
Checklist, Voltage 23
Check Under Peak Loads 16
Circ Pump 77
Circuit, Class A Ground Fault 20
circulation pump 77
Circulation Pump Modes 56
Class A GFCI 2
Class A Ground Fault Circuit 20
cleanup cycle 57
Clean-up (or purge) Cycle 77
Code, Canadian Electric 3
Code, Fault Message 70
Code, Message 70
Code, National Electrical 3
Codes and Compliance 3
Code, Set Up 75
Codes, Fault Log Message 70
Codes, M0[XX] numbers are Message 55
Codes, Message 67
codes, set up 75
code, system 21
colder climates 56
colors, background 63
Compatibility on Dual Board 51
Compliance, Codes and 3
condition, error 59
conditions, freezing 61
conductors, 6AWG copper 20
configuration, DIP switch for proper 50
Configuration Settings 44
Configuration Signature 67
configurations, setup 44
configuration, view the 44
connector, receiver's 74
connector, sensor 41
connector, terminal 52
Connector, Unlock 52
continue monitoring temperature 59
continuous duty appliance 3

Index

continuously, spa to filter 21
Control System 74
cord, AMP 43
cord, GFCI power 19
Current Setup 44
cycle, cleanup 57
Cycle, Clean-up (or purge) 77
Cycle, Filtration 77
cycle, second filter 56
cycles, filtration 56

D

DEMO (Demo Mode) 67
Demo Mode 44, 60
Depress sensor tab 41
Depress tab 48
different, LCD readouts may look slightly
67, 68
DIP Switch 1 44
DIP switch for proper configuration 50
DIP switch positions of S1 67
disconnect, electrical 19
disconnect, local 19
Disconnect, Local 19
Document No. 42012 75
Document No. 42013 75
Document No. 50211 75
Document No. 50212 75
Dolphin 74
Dolphin Address 75
Dolphin, Addressing your 75
Dolphin II 74
Dolphin III manual 75
Dolphin receiver 74
Dolphin™ Remote 74
Do not pry up 50
do not pull on the wires 50
down, spa is shut 68
dr 68
drainage, Adequate 2
Drain Mode 60
Draw, 120V 23
Draw, 120V Amp 23, 42
Draw, 230V Amp 23
Draw, 240V 23

Draw, 240V Amp 23, 42
Draw, Heater Amperage 42
Draw, Test the Amperage 19
Dry, Heater May be 68
duration 56

E

electrical disconnect 19
Electrical Protection 19
End User Warning 2
error condition 59
event, fault 70
exit Priming Mode 45
exit Test Mode 47
expander board 38, 50
Expander Board 24

F

failed, sensor circuit has 62
FALT LOG (Fault Log) 68
fault event 70
fault, ground 61
Fault Log 44, 58, 60, 70
Fault Log information 44
Fault Log Menu 70
Fault Log Message Codes 70
Fault Message Code 70
Fault, Sensor A 62
Fault, Sensor B 62
fault, Sensor Balance is Poor 69
faults, last 24 44
faults, Stray 48
Feature, GFCI Test 61
Filter Cycle 2 57
filtration 56
Filtration Cycle 77
filtration cycles 56
Filtration, Main 57
Filtration, Optional 57
flash, Heat LED will 20
Flashing Heat LED 20
flow problem 21
freeze protection 56, 59
Freeze Protection 68, 77

freezing conditions 61
fuse, Always test continuity of a 19
fuses, 30A pump 38
fuses, slow-blow 19
fuse, system power input 18

G

generator, ozone 56, 57
GFCI 19, 77
GFCI breaker 61
GFCI, Class A 2
GFCI power cord 19
GFCI should be reset immediately 61
GFCI should trip within several seconds 61
GFCI Test Feature 61
GFCI Trip Test 61
Glossary 77
GPM 76
ground fault 61
guard, VG Compliant suction 2
Guidelines, Motor Amperage 23
Guidelines, Spa 76

H

H, A vs B or T vs 48
Heater Amperage Draw 42
Heater Connector on BP2000/BP2100 52
Heater Flow is Reduced 68
heater kit with wires 52
Heater Matrix 23
Heater May be Dry 68
heater, no voltage to the 20
Heater Related Messages 59
heater, removing a 52
heater sensor wires 52
Heater terminal nut installation 52
Heater Type 23
Heater Voltage 67
Heater Wattage as Configured in Software
67
heater wires 52
Heat LED will flash 20
Heat Waiting 20
HFL 21, 68

Index

H _ (Heater Type) 67
High-Limit Sensor 23
High Temperature Range 54
Hot, HTR is too 68
Hot, Water is too 68
how to 61
HTR is too Hot 68

I

Identification, Software Self 77
ID, Software 59
ID, System Panel 77
immediately, GFCI should be reset 61
Information 58
information, Fault Log 44
Information, System 59
installation, Heater terminal nut 52
instructions, power connection 2
Interface, User 8
Invert 58
IR Receiver 74
isolate the logic board 41
Issues, System Related 16

L

last 24 faults 44
latest version 8
Law, Ohm's 32
LCD readouts may look slightly different
67, 68
LED, Flashing Heat 20
limits, amperage draw 19
Limit, Temp 44
Link the panel 45
Loads, Check Under Peak 16
Loads, Two Types of Peak 16
local disconnect 19
Local Disconnect 19
Lock 58
Locking the Panel 58
Locking the Settings 58
Lock, Settings 58
Log, Fault 44, 58, 60, 70
Logic board 41

Logic Board 41
Low Temperature Range 54

M

M0[XX] numbers are Message Codes 55
M015 62, 69
M016 59, 68
M017 59, 68
M019 68
M019* 55
M020 62, 69
M021 62, 69
M022 62, 69
M026 62, 69
M027 59
M028 59, 68
M029 62, 68
M030 59, 68
M031 69
M031, Sensor A: 62
M032 69
M032, Sensor B: 62
M033 68
M034 62, 69
M035 62, 69
M036 62, 69
M037* 57
Main Filtration 57
manual, Dolphin III 75
Matrix, Heater 23
Menu, Fault Log 70
Menus, Simplified 8, 44, 72
Menus, Standard 8, 44
Menu, System Information 67
Menu, Test 70
Menu, TEST 44
Menu, Utilities 60
Message Code 70
Message Codes 67
Messages 54
messages can be reset from the panel 62
Messages, Heater Related 59
Messages, Scrolling TP400/TP600 68
Messages that can be reset 62
messages will scroll 68

message with an asterisk 55
Miswiring of the spa is the most common
reason 19
Mode, Demo 44, 60
Mode, Drain 60
Mode, exit Priming 45
Mode, exit Test 47
models, TP panels work with both Revolu-
tion 8
Mode, Priming 68, 77
Mode, Ready 56
mode, test 20, 21
Mode, Test 44, 45, 46, 62
Mode., Test 21
MODL (System Model) 67
Motor Amperage Guidelines 23

N

National Electrical Code 3
NEC (National Electrical Code) 2
newer revision board 51
no voltage to the heater 20
nuisance spike 19
Number, Setup 45

O

OHH 68
OHH. 21
Ohms 23
Ohm's Law 32
Ohm Table 23
OHS 68
ON, Switch 1 44
Operation, Restricting 58
Optional Filtration 57
Outs, Time 44
out, Water may splash 52
overlapping filter times 21
ozone generator 56, 57

P

panel, Link the 45
panel, messages can be reset from the 62
panel, software in the topside control 67

Index

- panel stops operating 44
 - panels, TP600/TP400 44
 - panels, TP900/TP800 44
 - Panel, Unlocking the 58
 - Parts, Recommended 7
 - PASS should appear 61
 - period, time-out 56
 - Pins, Sensor 49
 - polling 56
 - power connection instructions 2
 - Preferences 77
 - pressure, Water under 52
 - prevent unwanted use 58
 - Priming Mode 68, 77
 - Problem 22
 - problem, blower 19
 - problem, board 49
 - problem, flow 21
 - problem, pump 19
 - problem, sensor 49
 - problem, suction 68
 - programmable circ pump 56
 - Programming 77
 - Programming Reference 8
 - properly reset the GFCI 61
 - Protection, Electrical 19
 - protection, freeze 56, 59
 - Protection, Freeze 68, 77
 - Pump, Circ 77
 - pump, circulation 77
 - pump problem 19
 - pump, programmable circ 56
 - Pumps, Troubleshooting 22
 - Pump Suction Blockage* 68
- R**
- Range, High Temperature 54
 - Range, Low Temperature 54
 - Ranges, Acceptable Heater Amperage Draw 23
 - Ranges, Acceptable Heater Ohm (Ω) 23, 34
 - Ranges, Amperage Draw 23
 - Ready Mode 56
 - reason, Miswiring of the spa is the most common 19
 - receiver, Dolphin 74
 - Receiver, IR 74
 - Receiver, RF 74
 - receiver's connector 74
 - Recommended Parts 7
 - red TB1 terminal 18
 - Reduced, Heater Flow is 68
 - Ref. Card 40947 8
 - Reference, Programming 8
 - reinstalling the board 51
 - release tab 50
 - REMOTE 74
 - Remote, Dolphin™ 74
 - removing a heater 52
 - Replacment Sensor 49
 - Required, Service Tools 7
 - reset, Messages that can be 62
 - reset the GFCI 61
 - Resistance, Troubleshooting 34, 35
 - Restricting Operation 58
 - RF Receiver 74
 - right arrow 62
 - RUN PMPS PURG AIR ---- 68
- S**
- S1 44
 - S1, DIP switch positions of 67
 - Safety Trip 68
 - Screen, Spa 56
 - Scrolling TP400/TP600 Messages 68
 - scroll, messages will 68
 - second filter cycle 56
 - Sensor A 44, 60
 - Sensor, A/B 44
 - Sensor A Fault 62
 - Sensor A: M031 62
 - sensor, Auxiliary freeze 56
 - Sensor B 44, 60
 - Sensor Balance is Poor fault 69
 - Sensor B Fault 62
 - Sensor B: M032 62
 - sensor circuit has failed 62
 - sensor connector 41
 - Sensor, High-Limit 23
 - Sensor Location BP500 41
 - Sensor Pins 49
 - sensor problem 49
 - Sensor, Replacment 49
 - sensor set 21, 49
 - sensor temperatures 21
 - Sensor Wires 7
 - Service Calls 7
 - Service Tools Required 7
 - SETP (Current Setup) 67
 - set, sensor 21, 49
 - Set Temperature 58
 - Settings, Configuration 44
 - Settings Lock 58
 - setup, Change the 44
 - Set Up Code 75
 - set up codes 75
 - setup configurations 44
 - Setup, Current 44
 - Setup Number 45
 - Setups, Software 44
 - shimmer 20
 - SIG 67
 - Signature, Configuration 67
 - Simplified Menus 8, 44, 72
 - slice valves 52
 - slow-blow fuses 19
 - software compatability 8
 - Software ID 59
 - software in the topside control panel 67
 - Software Self Identification 77
 - Software Setups 44
 - software, test 62, 69
 - Spa Address 75
 - Spa Guidelines 76
 - spa is shut down 68
 - Spa Screen 56
 - spa to filter continuously 21
 - spike, nuisance 19

Index

SSID 59, 77
SSID (Software ID) 67
Standard Menus 8, 44
Stray faults 48
suction problem 68
SW_ (Dip Switch Settings) 67
Switch 1 45
Switch 1 ON 44
system code 21
System, Control 74
System Information 59
System Information Menu 67
System Panel ID 77
system power input fuse 18
System Related Issues 16

T

tab, Depress 48
tab, Depress sensor 41
Table, Ohm 23
tab, release 50
TB1 17
Tech Sheets 8
temperature, continue monitoring 59
temperature display will alternate 60
Temperatures, A/B Sensor 44
Temperature, Set 58
temperatures, sensor 21
Temp Limit 44
Temps, A/B 60
terminal connector 52
terminal, red TB1 18
test button 61
Test, GFCI Trip 61
Testing, Acceptable Ranges for 23
Test Menu 70
TEST Menu 44
Test Menu Access 44
test mode 20, 21
Test Mode 44, 45, 46, 62
Test Mode. 21
test software 62, 69
Test the Amperage Draw 19

Test the ground fault circuit interrupter 2
time-out period 56
Time Outs 44
times, overlapping filter 21
torque, 30 - 35 in lbs. 52
Torque main board 51
TP600/TP400 panels 44
TP900/TP800 panels 44
TP panels work with all BP 8
TP panels work with both Revolution models 8
Trip, Safety 68
Troubleshooting Pumps 22
Troubleshooting Resistance 34, 35
Two Types of Peak Loads 16
Type, Heater 23

U

Unlock Connector 52
Unlocking the Panel 58
User Guide 40940 8
User Guide 40985 8
User Guide 42185 8
User Interface 8
Utilities 58
Utilities Menu 60

V

valves, ball 52
valves, slice 52
version, latest 8
VG Compliant suction guard 2
view the configuration 44
Voltage Checklist 23

W

Waiting, Heat 20
Warning, End User 2
Water is too Hot 68
Water may splash out 52
Water under pressure 52
Watts, 120V 23

Watts, 230V 23
Watts, 240V 23
wire, 30344 sensor 7
wire, amperage at the red pump 19
wire, black blower 19
wires, BP2000 board without 51
wires, do not pull on the 50
wires, heater 52
wires, heater kit with 52
wires, heater sensor 52
Wires, Sensor 7
wiring changes 44

Index of Paragraph Topics

0.3A Slo-Blo	7	All TP Panels have “Molex” Type Connectors.	9
0.3A Slo-Blo	33	All voltages specified as 120 V or 240 V, may show an acceptable variance of +/- 10%.	23
0.15A Slo-Blo	7	A message with an asterisk [*] can be reset from the topside panel.	55
0.15A Slo-Blo	33	Amperage Draw Ranges	23
0.125A Slo-Blo	7	Amperage Heater Test BP500.	42
0.125A Slo-Blo	33	Amperage Heater Test BP2000G1	42
3A Slo-Blo	7	A Pump Appears to be Stuck ON – M034	69
3A Slo-Blo	33	A Pump Appears to have been Stuck ON when spa was last powered – M035	69
10A	7	A pump may be stuck on – M034.	62
10A	33	A Reset Message May Appear with other Messages.	69
30A	7	Assigning a new address to the Dolphin	75
30A	33	A Standard Main Menu (Doc No. 40941I)	73
120V Draw	23	Avoid damaging the post. Use an end wrench on the lower nut to reinforce the post when removing the upper nut.	53
240V Draw	23	Be sure that both clamps are not making contact with anything below the insulating material on the terminal (arrows).	40
20600	7	Be sure to set the Time-of-Day	56
20600	33	BE SURE TO TURN THE POWER OFF BEFORE REPLACING ANY COMPONENT, ESPECIALLY A CIRCUIT BOARD.	50
21581	7	BP500 BP2000G1	1
21581	33	BP2000 Circuit Board	7
26281	7	BP2100 board screw locations	51
26281	33	BP2100 board without wires	51
26397	7	Brown Outs	18
26397	33	BWG Part Number.	7
30122	7	BWG Part Number.	33
30122	33	CE Product:	61
30136	7	changing menus through configurations	72
30136	33	Check for Loose Connections or Damaged Wires	17
A / B (A/B Sensor Temperatures)	68	Checking the System Power Input Fuse.	18
A/B Temps	60	Circ Pump (or circulation pump)	77
A/B Temps (A/B Sensor Temperatures)	44	Circulation Pump Modes	56
Acceptable Heater Amperage Draw Ranges	23	Cleanup	63
Acceptable Heater Amperage Draw Ranges	42	Cleanup Cycle (optional)	57
Acceptable Heater Ohm (Ω) Ranges	23	Clean-up (or purge) Cycle	77
Acceptable Heater Ohm (Ω) Ranges	34		
A common programming mistake is overlapping filter times that may cause the spa to filter continuously.	21		
A fuse with the meter reading “bad”	33		
A fuse with the meter reading “good”	33		

Index of Paragraph Topics (cont.)

Color of Background	63	Fault Log: tp800, tp900	60
Communications error.	62	---°F ---°C	62
Compatibility on Dual Board Control Systems	51	Filter Cycle 2 - Optional Filtration.	57
Configuration Error - Spa will not Start Up	62	Filtration and Ozone.	56
Configuration Error - Spa will not Start Up	69	Filtration Cycle	77
Configuration Signature	59	Flashing Heat LED on TP600 ("Heat Waiting")	20
Continuity	32	Flow-Related Checks	59
Current Setup	59	Flow-Related Checks	69
DEMO (Demo Mode)	44	Forcing the GFCI Trip Test.	61
DEMO (Demo Mode)	67	°F or °C is replaced by °T	62
Demo Mode	60	°F or °C is replaced by °T	69
Depress sensor tab when removing	41	Freeze condition.	21
Depress tab when removing	48	Freeze Protection	56
Device	23	Fuse	7
Dip Switch Settings	59	Fuse	33
Dolphin	74	Fuses Used on BP spa Systems.	7
Dolphin II and Dolphin III (Applies to RF Dolphin only)	63	Fuses Used on BP spa Systems.	33
Dolphin III (50211)	75	GFCI	77
Dolphin III CE (50212).	75	GFCI Failure - System Could Not Test/Trip the GFCI – M036	69
Dolphin Manual	75	GFCI Test (Feature not available on CE rated systems.)	60
Dolphin Receiver	74	Ground-Fault Circuit Interrupter/Circuit Breaker (G.F.C.I.)	11
Dolphin Remotes	75	Ground in System Enclosure	10
Do not measure across heater terminals	39	Heater Assembly	7
DO NOT REMOVE AND REPLACE THE CIRCUIT BOARD UNLESS THE FAULT HAS POSITIVELY BEEN DETERMINED TO BE THE CIRCUIT BOARD.	50	Heater Connector on BP2000/BP2100 Series.	52
Drain Mode	60	Heater Element Specifications Are Shown on the Heater Tube Label	9
Electrical Protection.	19	Heater Flow is Reduced (HFL) – M016	68
Exiting Priming Mode	55	Heater Flow is Reduced (LF)* – M017	68
Exiting Priming Mode	66	Heater Matrix	23
F6 and F8 are on the main board. F1 is located on the expander board.	38	Heater May be Dry (dr)* – M028	68
F6 Fuse	18	Heater Related Messages	59
F6 to TB1 Red	38	Heater Start Up Information	20
FALT LOG (Fault Log)	44	Heater Type	59
FALT LOG (Fault Log)	68	Heater Voltage (Feature not used on CE rated systems.)	59
Fault Log Message Codes: TP400, TP600.	70	Heater Voltage (Feature not used on CE rated systems)	67
		Heater Wattage as Configured in Software (CE Systems Only)	59
		Heater Wattage as Configured in Software (CE Systems Only)	67

Index of Paragraph Topics (cont.)

Heater Wires on a BP500/BP600 Series system are connected to the lower Power Board.	53	Note: These are typical settings only. Voltages may be different depending on the configuration that the system is set to. See the system's Tech Sheet for complete information.	43
Heat LED in Heat Waiting Mode, TP600	20	Observe safety at all times	36
H _ (Heater Type)	67	Ohm's Law.	32
Hold Mode - M037*	57	Once the power input fuse has been changed	18
Hot fault – M035	62	On Every System, an Identification Label Is Placed on Top of the Casing	9
How the Dolphin Works.	74	On Every System, a Wiring Diagram Is Placed Inside the Door	9
HTR is too Hot (OHH)* M030	68	On Expander Board	24
If Correct Wiring is Verified.	11	Panels	1
If the problem stays with the same sensor (according to topside messages) it's a board problem; if the problem moves to the other sensor it's a sensor problem.	49	Panel Version	59
INFO (System Information sub-menu).	67	PANL (Panel Version)	67
Installing a System Circuit Board	51	Place clamp around one heater wire, and then the other wire.	42
Language	63	Place the meter probes on the heater terminals.	34
Locking nuts are in the same location on other BP models	53	Possible freezing condition	62
Logic Jumper, No. 20618	7	Preferences	63
Low Voltage	18	Preferences	77
M0[XX] numbers are Message Codes.	55	Preliminary Panel Check.	20
M-7 Replacement Sensor.	49	Preparation and Filling	55
Main Filtration.	57	Preparation and Filling	66
Measure resistance from a heater post to the heater housing	35	Pre-Production Software	69
Memory Failure - Checksum Error* – M022	69	Press-and-Hold	54
Memory Failure - Clock Error* – M020	69	Priming Mode –	55
Memory Warning - Persistent Memory Reset* – M021	69	Priming Mode – M019	68
Message Codes	21	Priming Mode – M019*	66
Message Codes	67	Priming the Pumps	55
Messages	54	Priming the Pumps	66
MODL (System Model)	67	Program memory failure* – M022	62
Most messages and alerts will appear at the bottom of the normally used screens.	62	Programming	77
Most Probable Overheating Causes, Inspect These First.	21	Pull the connector straight out.	34
Motor Amperage Guidelines	23	Pull the connector straight out.	35
Navigation	54	Pump 1 AMP cord	43
No Communications.	69	Pumps	56
Note: Be careful when removing a heater assembly from a spa plumbing system. Water may splash out under pressure. See next page for more illustrations.	52	Purge Cycles.	57
		Recommended Parts to have For Service Calls	7
		Red to Black Wires = 240V	37

Index of Paragraph Topics (cont.)

Reminders	63	TB1	17
Remove both nuts that secure the element in place.	53	TB1 Marking on Board	18
Removing a System Circuit Board.	50	Temp Display	63
Removing BP Expander Board, an Alternate Way	50	Temperature & High-Limit Sensor Ohm Table	23
Restricting Operation (Locking the Panel).	58	Temp Limit.	44
Safety and Electrical Systems	20	Terminal Block 1 & F5 Fuse on a BP500 Power Board, 240V Setup 18	
Safety Trip - Pump Suction Blockage* – M033.	68	Terminal Block 1 & F6 Fuse on a BP2000 Board	18
Saving Settings	56	Testing a Fuse: Check continuity with the fuse removed.	33
Saving Your Dolphin Address	75	Testing low speed and High Speed at the AMP Connector	43
Scrolling TP400/TP600 Messages	68	Testing Sensor Pins	49
Sensor A Fault, Sensor B Fault – Sensor A: M031, Sensor B: M032 62		Test Menu Access (S1, Switch 1 ON).	44
Sensor Balance is Poor – M015.	69	Test Mode.	21
Sensor Balance is Poor* – M026	69	Test software installed	62
Sensor Failure – Sensor A: M031, Sensor B: M032	69	Test the Amperage Draw	19
Sensor Location BP500, on Logic Board	41	The clock has failed* – M020	62
Sensor Pins: At times, a protective coating may on accident coat the sensor pins during manufacturing. Those pins may need to be scraped and the sensors plugged back in.	49	The Control System is in Test Mode if 102°T appears. (In this case °F or °C is replaced by °T.)	44
Sensors are out of sync -- Call for service* – M026	62	The Dolphin™ Remote	74
Sensors are out of sync – M015	62	The Fault Log	70
Service Tools Required	7	The following ranges represent general parameters for many different motors and applications. Check the device label or with the spa manufacturer to get accurate amperage draws.	23
SETP (Current Setup)	67	The GFCI test failed (System Could Not Test the GFCI) – M036	62
Side View: Depress Tab to Unlock Connector	52	The Ground Fault Circuit Interrupter (GFCI).	61
SIG (Configuration Signature).	67	The heater is dry* – M027	59
Simplified Menus	72	The heater is too hot* – M030	59
Software Setups	44	The heater may be dry* – M028	59
Software Setups (BP2500)	47	The Logic Board must be removed to access and remove the heater wires, shown in red.	53
Some Troubleshooting Scenarios.	21	The preferred way to check for fuse continuity is with the fuses removed from the circuit.	33
Spa Control Systems	1	There are three 30A pump fuses in the BP2000G1 spa control system.	38
Spa Status	54	These readings should be taken under peak load conditions.	19
SSID	77	The settings have been reset (Persistent Memory Error)* – M021 62	
SSID (Software ID)	67	The Utilities Menu contains the following:	63
SW _ (Dip Switch Settings).	67	The water flow has failed* – M017	59
System Box Wire Gauge Check	17		
System Information	59		
System Model	59		

Index of Paragraph Topics (cont.)

The water flow is low – M016	59	Wiring Check Precautions.	17
The water is too hot – M029	62	With the pump high speed ON, take a voltage reading at the AMP receptacle on the PCB.	43
This would typically show High speed voltage for Pump one. (240V) 43		With the pump low speed ON, take a voltage reading at the AMP receptacle on the PCB.	43
This would typically show low speed voltage for Pump one. (240V) 43			
Time Display	63		
Time Outs	44		
Tip: If one sensor (A or B) seems to be having problems, swap the cables of sensor A with sensor B.	49		
To Determine the Cause of a Blown Power Input Fuse.	19		
To Disconnect the Heater.	11		
Too Cold - Freeze Protection	68		
TP400/TP600 error codes and fault messages are similar to TP800/TP900.	64		
TP900, TP800, TP600, TP400	1		
Troubleshooting Heater Posts Resistance to Heater Housing	35		
Troubleshooting heater Resistance.	34		
Unlocking the Panel	58		
Used for verifying a proper installation.	61		
Verifying Incoming Voltage at the Terminal Block (240V system) BP2000 shown (BP500 system is similar)	37		
Verify that there is no heater “leakage”	35		
Verify there is NO continuity from the heater post to the ground/earth. On the resistance scale, the a digital meter should read OL (indicating infinite resistance).	35		
Verify there is NO continuity from the heater post to the heater housing or heater current collector connection. The meter reading shown is OL, indicating infinite resistance.	35		
Viewing Configuration Settings.	44		
Voltage Checklist	23		
Warning: The Owner should test and reset the G.F.C.I. on a regular basis to verify its function.	11		
Water is too Hot (OHS) – M029.	68		
Water Temperature is Unknown	62		
Water Temperature is Unknown	68		
What Priming Mode does:	77		
White to Black Wires = 120V	37		
White to Red Wires = 120V.	37		

